

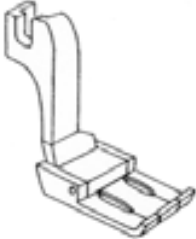





PIEDINI PER PFAFF













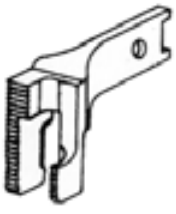

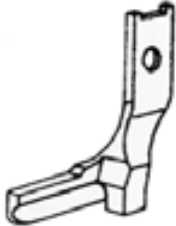

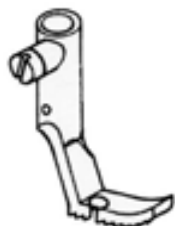

cl. 138, 141, 238

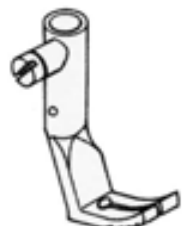









			
ER111C000236 46682 Cucitura diritta	ER111C000237 43522 Zig-Zag	ER111CP26473 26473 Cordonatore destro	ER111CP26474 26474 Cordonatore sinistro
	Destro		
	ER111CP610P	1/32"=0,8	
	ER111CP611P	1/16"=1,6	
	ER111CP612P	1/8"=3,2	
	ER111CP613P	3/16"=4,8	
	ER111CP614P	1/4"=6,4	
	Sinistro		
	ER111CP620P	1/32"=0,8	
	ER111CP621P	1/16"=1,6	
	Doppio		
ER111CP630P	1/32"=0,8		
ER111CP631P	1/16"=1,6		
Destro stretto			
ER111CP611NP	1/16"=1,6		
Piedino compensatore			ER111CPP38ZZ 630 ZZ Compensatore doppio Z/Z





cl. 142, 1242



								
Piedino per macchina 2 aghi Suola regolare	Piedino 2 aghi con guida dx mm.2	Compensatore destro 1/16"	Compensatore doppio 1/16"					
Codice	Origin.	Misura	Codice	Misura	Codice	Misura	Codice	Misura
ER111CN30715	30715	mm.4,8	ER111CND9248	mm.4,8	ER111CN92D48	mm.4,8	ER111CN92P48	mm.4,8
ER111CN61044	961044	mm.6,0	ER111CND9264	mm.6,4	ER111CN92D64	mm.6,4	ER111CN92P64	mm.6,4
ER111CN61144	961044	mm.6,4						
Suola stretta								
ER111CN92048		mm.4,8						
ER111CN92064		mm.6,4						
	Codice	Original e	Misura		Codice	Originale	Misura	
	ER111CN61070	961070	mm. 4,0		ER111CN61320	961320	mm. 4,0	
	ER111CN61231	961231	mm. 6,0		ER111CN61339	961339	mm. 6,0	
	ER111CN61232	961232	mm. 6,4		ER111CN61840	961840	mm. 6,4	
	ER111CN61065	961065	mm. 8,0		ER111CN61062	961062	mm. 8,0	
	ER111CN61081	961081	mm. 10		ER111CN61078	961078	mm. 10	
	ER111CN61091	961091	mm. 12		ER111CN61088	961088	mm. 12	
	ER111CN61105	961105	mm. 14		ER111CN61102	961102	mm. 14	
	ER111CN61117	961117	mm. 16		ER111CN61114	961114	mm. 16	
	ER111CN61132	961132	mm. 20		ER111CN61129	961129	mm. 20	
Piedino esterno 2 aghi				Piedino interno 2 aghi				

cl. 145, 146, 335, 545

	Scanalato esterno ago destra 49544			Scanalato interno ago destra 49047	
	Codice	Misura		Codice	Misura
	ER111CP54418	1/8"		ER111CP04718	1/8"
	ER111CP54452	5/32"		ER111CP04752	5/32"
	ER111CP54436	3/16"		ER111CP04736	3/16"
	ER111CP54414	.1/4"		ER111CP04714	.1/4"
	ER111CP54456	5/16"		ER111CP04756	5/16"
ER111CP54438	3/8"	ER111CP04738	3/8"		
	Scanalato esterno ago destra 49544T			Scanalato esterno ago destra 49544T	
	Codice	Misura		Codice	Misura
	ER111CP54T18	1/8"		ER111CP04T18	1/8"
	ER111CP54T52	5/32"		ER111CP04T52	5/32"
	ER111CP54T36	3/16"		ER111CP04T36	3/16"
	ER111CP54T14	.1/4"		ER111CP04T14	.1/4"
	ER111CP54T56	5/16"		ER111CP04T56	5/16"
ER111CP54T38	3/8"	ER111CP04T38	3/8"		
 Scanalato esterno ago destra 42443 ER111CP44336 3/16" ER111CP44314. 1/4"	 Scanalato interno ago destra 42442 ER111CP44236 3/16" ER111CP44214. 1/4"	 Scanalato doppio esterno 42180 ER111CP21801 3/16" ER111CP21802. 1/4"	 Scanalato doppio interno 42180 ER111CP21811 3/16" ER111CP21812 .1/4"		
 ER111CP49558 49558 C-D	 ER111CP49085 49085 C	 ER111CP46970 46970	 ER111CP47404 40474-4	 ER111CP47505 40475-5	 ER111CP47405 40474-5
 ER111CP47506 40475-6	 ER111CP47406 40474-6	 ER111CP47508 40475-8	 ER111CP47408 40474-8	 ER111CP44227 44227	 ER111CP42819 42819

							
Scanalato destro esterno		Scanalato ago a destra interno		Scanalato destro esterno		Scanalato ago a destra interno	
Codice	Misura	Codice	Misura	Codice	Misura	Codice	Misura
ER111CNE1D02	mm. 2	ER111CAADD02	mm. 2	ER111CNE1D02	mm. 2	ER111CABDD02	mm. 2
ER111CNE1D03	mm. 3	ER111CAADD03	mm. 3	ER111CNE1D03	mm. 3	ER111CABDD03	mm. 3
ER111CNE1D04	mm. 4	ER111CAADD04	mm. 4	ER111CNE1D04	mm. 4	ER111CABDD04	mm. 4
ER111CNE1D05	mm. 5	ER111CAADD05	mm. 5	ER111CNE1D05	mm. 5	ER111CABDD05	mm. 5
ER111CNE1D06	mm. 6	ER111CAADD06	mm. 6	ER111CNE1D06	mm. 6	ER111CABDD06	mm. 6
ER111CNE1D07	mm. 7	ER111CAADD07	mm. 7	ER111CNE1D07	mm. 7	ER111CABDD07	mm. 7
ER111CNE1D08	mm. 8	ER111CAADD08	mm. 8	ER111CNE1D08	mm. 8	ER111CABDD08	mm. 8
ER111CNE1D09	mm. 9	ER111CAADD09	mm. 9	ER111CNE1D09	mm. 9	ER111CABDD09	mm. 9
ER111CNE1D10	mm. 10	ER111CAADD10	mm. 10	ER111CNE1D10	mm. 10	ER111CABDD10	mm. 10
ER111CNE1D11	mm. 11	ER111CAADD11	mm. 11	ER111CNE1D11	mm. 11	ER111CABDD11	mm. 11
ER111CNE1D12	mm. 12	ER111CAADD12	mm. 12	ER111CNE1D12	mm. 12	ER111CABDD12	mm. 12
							
Scanalato destro esterno		Scanalato ago a destra interno		Scanalato sinistro esterno		Scanalato ago a sinistra interno	
Codice	Misura	Codice	Misura	Codice	Misura	Codice	Misura
ER111CNE2D02	mm. 2	ER111CACDL02	mm. 2	ER111CNE4S02	mm. 2	ER111CAESL02	mm. 2
ER111CNE2D03	mm. 3	ER111CACDL03	mm. 3	ER111CNE4S03	mm. 3	ER111CAESL03	mm. 3
ER111CNE2D04	mm. 4	ER111CACDL04	mm. 4	ER111CNE4S04	mm. 4	ER111CAESL04	mm. 4
ER111CNE2D05	mm. 5	ER111CACDL05	mm. 5	ER111CNE4S05	mm. 5	ER111CAESL05	mm. 5
ER111CNE2D06	mm. 6	ER111CACDL06	mm. 6	ER111CNE4S06	mm. 6	ER111CAESL06	mm. 6
ER111CNE2D07	mm. 7	ER111CACDL07	mm. 7	ER111CNE4S07	mm. 7	ER111CAESL07	mm. 7
ER111CNE2D08	mm. 8	ER111CACDL08	mm. 8	ER111CNE4S08	mm. 8	ER111CAESL08	mm. 8
ER111CNE2D09	mm. 9	ER111CACDL09	mm. 9	ER111CNE4S09	mm. 9	ER111CAESL09	mm. 9
ER111CNE2D10	mm. 10	ER111CACDL10	mm. 10	ER111CNE4S10	mm. 10	ER111CAESL10	mm. 10
ER111CNE2D11	mm. 11	ER111CACDL11	mm. 11	ER111CNE4S11	mm. 11	ER111CAESL11	mm. 11
ER111CNE2D12	mm. 12	ER111CACDL12	mm. 12	ER111CNE4S12	mm. 12	ER111CAESL12	mm. 12
		Codice				Codice	
Scanalato sinistro esterno		ER111CNE5S02		Scanalato ago a sinistra interno		ER111CAFSD02	
		ER111CNE5S03				ER111CAFSD03	
		ER111CNE5S04				ER111CAFSD04	
		ER111CNE5S05				ER111CAFSD05	
		ER111CNE5S06				ER111CAFSD06	
		ER111CNE5S07				ER111CAFSD07	
		ER111CNE5S08				ER111CAFSD08	
		ER111CNE5S09				ER111CAFSD09	
		ER111CNE5S10				ER111CAFSD10	
		ER111CNE5S11				ER111CAFSD11	
		ER111CNE5S12				ER111CAFSD12	
						Misura	
		mm. 2				mm. 2	
		mm. 3				mm. 3	
		mm. 4				mm. 4	
		mm. 5				mm. 5	
		mm. 6				mm. 6	
		mm. 7				mm. 7	
		mm. 8				mm. 8	
		mm. 9				mm. 9	
		mm. 10				mm. 10	
		mm. 11				mm. 11	
		mm. 12				mm. 12	

							
Sagomato destro esterno		Sagomato ago a destra interno		Sagomato destro esterno		Sagomato ago a destra interno	
Codice	Misura	Codice	Misura	Codice	Misura	Codice	Misura
ER111CNE7D03	mm. 3	ER111CAHDL03	mm. 3	ER111CNE6D03	mm. 3	ER111CAGDL03	Mm. 3
ER111CNE7D04	mm. 4	ER111CAHDL04	mm. 4	ER111CNE6D04	mm. 4	ER111CAGDL04	Mm. 4
ER111CNE7D05	mm. 5	ER111CAHDL05	mm. 5	ER111CNE6D05	mm. 5	ER111CAGDL05	Mm. 5
ER111CNE7D06	mm. 6	ER111CAHDL06	mm. 6	ER111CNE6D06	mm. 6	ER111CAGDL06	Mm. 6
ER111CNE7D07	mm. 7	ER111CAHDL07	mm. 7	ER111CNE6D07	mm. 7	ER111CAGDL07	Mm. 7

							
Sagomato destro esterno		Sagomato ago a sinistra interno		Sagomato sinistro esterno		Sagomato ago a destra interno	
Codice	Misura	Codice	Misura	Codice	Misura	Codice	Misura
ER111CNE3D02	mm. 2	ER111CADD02	mm. 2	ER111CNE8D02	mm. 2	ER111CAIDD02	Mm. 2
ER111CNE3D03	mm. 3	ER111CADD03	mm. 3	ER111CNE8D03	mm. 3	ER111CAIDD03	Mm. 3
ER111CNE3D04	mm. 4	ER111CADD04	mm. 4	ER111CNE8D04	mm. 4	ER111CAIDD04	Mm. 4
ER111CNE3D05	mm. 5	ER111CADD05	mm. 5	ER111CNE8D05	mm. 5	ER111CAIDD05	Mm. 5
ER111CNE3D06	mm. 6	ER111CADD06	mm. 6	ER111CNE8D06	mm. 6	ER111CAIDD06	Mm. 6
ER111CNE3D07	mm. 7	ER111CADD07	mm. 7	ER111CNE8D07	mm. 7	ER111CAIDD07	Mm. 7
ER111CNE3D08	mm. 8	ER111CADD08	mm. 8	ER111CNE8D08	mm. 8	ER111CAIDD08	Mm. 8

PIEDINI A BILANCINO PER PFAFF

	ALTO			<p>ER111CBIP008 Piedino a bilancino doppio per piedino interno fino a 8 mm..</p> <p>ER111CBIP010 Piedino a bilancino doppio per piedino interno fino a 10 mm..</p>
	Codice	Misura		
	ER111CNBIA48	mm. 4,8		
	ER111CNBIA60	mm. 6,0		
	ER111CNBIA64	mm. 6,4		
	ER111CNBIA80	mm. 8,0		
	ER111CNBIA10	mm. 10,0		
	ER111CNBIA12	mm. 12,0		
	BASSO			
	ER111CNBIB48	mm. 4,8		
	ER111CNBIB60	mm. 6,0		
	ER111CNBIB64	mm. 6,4		
ER111CNBIB80	mm. 8,0			
ER111CNBIB10	mm. 10,0			
ER111CNBIB12	mm. 12,0			

	<p>Piedino a bilancino doppio</p> <p>ER111CBID010 mm.1 ER111CBID020 mm.2</p>		<p>Piedino bilancino destro</p> <p>ER111CBIDS10 mm.1,0 ER111CBIDS15 mm.1,5 ER111CBIDS25 mm.2,0</p>
---	---	--	---

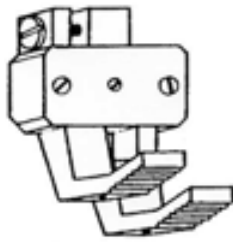

BASSI (2 VITI FRONTE)



ALTI (4 VITI FRONTE)

Dentato		Liscio		Con Guida centrale	
ALTO		ALTO		ALTO	
Codice	Misura	Codice	Misura	Codice	Misura
ER111CABID48	mm. 4,8	ER111CABIL48	mm. 4,8	ER111CBIC048	mm. 4,8
ER111CABID60	mm. 6,0	ER111CABIL60	mm. 6,0	ER111CBIC060	mm. 6,0
ER111CABID64	mm. 6,4	ER111CABIL64	mm. 6,4	ER111CBIC064	mm. 6,4
ER111CABID80	mm. 8,0	ER111CABIL80	mm. 8,0	ER111CBIC080	mm. 8,0
ER111CABID10	mm. 10,0	ER111CABIL10	mm. 10,0	ER111CBIC100	mm. 10,0
BASSO		BASSO		BASSO	
ER111CABBD48	mm. 4,8	ER111CABBL48	mm. 4,8	ER111CBBC048	mm. 4,8
ER111CABBD60	mm. 6,0	ER111CABBL60	mm. 6,0	ER111CBBC060	mm. 6,0
ER111CABBD64	mm. 6,4	ER111CABBL64	mm. 6,4	ER111CBBC064	mm. 6,4
ER111CABBD80	mm. 8,0	ER111CABBL80	mm. 8,0	ER111CBBC080	mm. 8,0
ER111CABBD10	mm. 10,0	ER111CABBL10	mm. 10,0	ER111CBBC100	mm. 10,0

cl. 438, 442



Piedino Zig Zag
cl. 438

ER111CP43835 mm.3,5
 ER111CP43860 mm.6,0

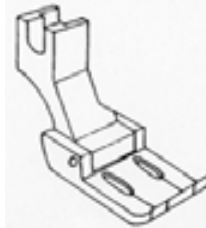

Piedino per macchina
2 aghi cl. 442
 ER111CP44248 mm.4,8
 ER111CP44264 mm.6,4

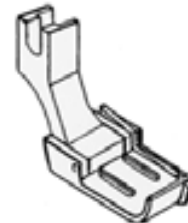

2 aghi con guida cl. 442







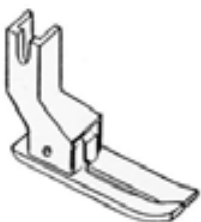







Guida destra		Guida sinistra	
mm. 1		mm. 1	
ER111CPD481	mm.4,8	ER111CPS481	mm.4,8
ER111CPD641	mm.6,4	ER111CPS641	mm.6,4
mm.2		mm.2	
ER111CPD482	mm.4,8	ER111CPS481	mm.4,8
ER111CPD642	mm.6,4	ER111CPS641	mm.6,4



















cl. 461, 481



COMPENSATORI









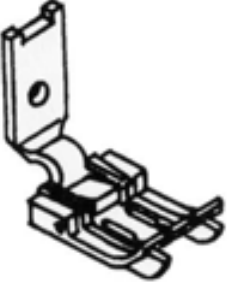
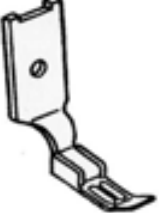











Destro		Destro Stretto	
ER111CPD1132	1/32"=0,8	ER111CPD132N	1/32"N=0,8
ER111CPD1116	1/16"=1,6	ER111CPD116N	1/16"N=1,6
		Sinistro	
ER111CPD1018	1/8" =3,2	ER111CPS1132	1/32"=0,8
ER111CPD1316	3/16"=4,8	ER111CPS1116	1/16"=1,6
ER111CPD1014	1/4" =6,4	ER111CPS1018	1/8" =3,2
ER111CPD1072	mm. 7,2	ER111CPS1316	3/16"=4,8
ER111CPD1080	mm. 8,0	ER111CPS1014	1/4" =6,4
ER111CPD1090	mm. 9,0	Sinistro Stretto	
ER111CPD1100	mm. 10	ER111CPS132N	1/32"N=0,8
ER111CPD1127	mm. 12,7	ER111CPS116N	1/16"N=1,6
ER111CPD1140	mm. 14	Doppio	
ER111CPD1160	mm. 16	ER111CPP1132	1/32"=0,8
ER111CPD1180	mm. 18	ER111CPP1116	1/16"=1,6

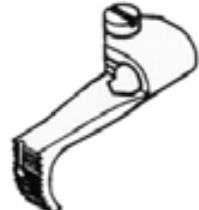
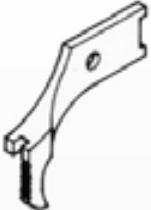

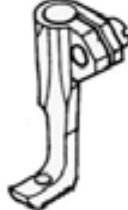

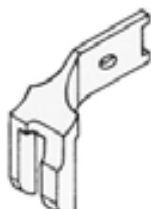
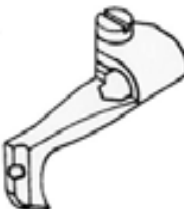

			
ER111CD700TE Piedino teflon	ER111CD700TB Ciabatta di ricambio	ER111CD7518F Piedino cern. invisibile	ER111CD7518N Piedino cern. invisibili con indice
			
ER111CD7361N Piedino cerniera destro	ER111CD7360N Piedino cerniera sinistro	ER111CD7363V Piedino cerniera	ER111CD7CREG Piedino cerniera regolabile
			
ER111CD7CC54 Piedino cerniera mm.5,4 ER111CD7CC70 Piedino cerniera mm. 7	ER111CD7CD54 Cerniera dx mm.5,4 ER111CD7CD70 Cerniera dx mm. 7	ER111CD7CS54 Cerniera sx mm.5,4 ER111CD7CS70 Cerniera sx mm. 7	
PIEDINI PER SINGER			
			
ER111CS41566 541566 mm. 10	ER111CS41781 541781 mm. 10	ER111CS43939 543939 mm. 12	
			
ER111C000200 Zig Zag mm. 6 210569 cl. 107G, 107W, 143W, 307G, 457G, 457U	ER111C000201 Zig Zag mm. 5 241375 cl. 107G, 107W, 143W, 307G, 457G, 457U	ER111C000202 Grezzo S107B cl. 107G, 107W, 143W, 307G, 457G, 457U	ER111C000203 Gambo 210620 cl. 107G, 107W, 143W, 307G, 457G, 457U

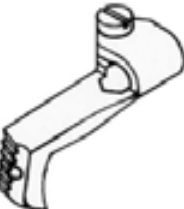
 <p>ER111C000204 Regolare 229882 cl. 111W, 211W, 211G</p>	 <p>ER111C23706 23706 Compensatore sinistro</p>	 <p>ER111C23707 23707 Compensatore destro</p>	 <p>ER111C266125 266125 Compensatore doppio</p>												
 <p>ER111CS11314 411314</p>	 <p>ER111CS03736 503736</p>	 <p>ER111CS03660 503660</p>	 <p>ER111CS13144 411314-4</p>												
 <p>ER111CS107CL 107 CL mm. 6 Compensatore sinistro</p>	 <p>ER111CS107CR 107 CR mm. 6 Compensatore destro</p>	 <p>ER111CSPFA1L PF-A1L mm. 10 Compensatore sinistro</p>	 <p>ER111CSPFA1R PF-A1R mm. 10 Compensatore destro</p>	 <p>ER111CS0521Z 521Z Compensatore sinistro</p>											
 <p>ER111CS07SCL 107 SCL mm. 6 Guida sinistra</p>	 <p>ER111CS07SCR 107 SCR mm. 6 Guida destra</p>	 <p>Piedino orlatore</p> <table border="1" data-bbox="877 1299 1220 1556"> <thead> <tr> <th>Codice</th> <th>Misura</th> </tr> </thead> <tbody> <tr> <td>ER111CS45725</td> <td>mm. 2,5</td> </tr> <tr> <td>ER111CS45730</td> <td>mm. 3,0</td> </tr> <tr> <td>ER111CS45740</td> <td>mm. 4,0</td> </tr> <tr> <td>ER111CS45750</td> <td>mm. 5,0</td> </tr> <tr> <td>ER111CS45760</td> <td>mm. 6,0</td> </tr> </tbody> </table>	Codice	Misura	ER111CS45725	mm. 2,5	ER111CS45730	mm. 3,0	ER111CS45740	mm. 4,0	ER111CS45750	mm. 5,0	ER111CS45760	mm. 6,0	 <p>ER111CS0564A 210564 A4 Zig Zag per bordatori</p>
Codice	Misura														
ER111CS45725	mm. 2,5														
ER111CS45730	mm. 3,0														
ER111CS45740	mm. 4,0														
ER111CS45750	mm. 5,0														
ER111CS45760	mm. 6,0														
 <p>ER111CS457AT S457 AT mm. 10 Zig Zag con passa nastro</p>	 <p>Piedino guida regolabile</p>	<table border="1" data-bbox="1061 1713 1516 1870"> <thead> <tr> <th>Codice</th> <th>Misura</th> </tr> </thead> <tbody> <tr> <td>ER111CS71S06</td> <td>mm. 6</td> </tr> <tr> <td>ER111CS71S08</td> <td>mm. 8</td> </tr> <tr> <td>ER111CS71S10</td> <td>mm. 10</td> </tr> <tr> <td>ER111CS71S12</td> <td>mm. 12</td> </tr> </tbody> </table>	Codice	Misura	ER111CS71S06	mm. 6	ER111CS71S08	mm. 8	ER111CS71S10	mm. 10	ER111CS71S12	mm. 12			
Codice	Misura														
ER111CS71S06	mm. 6														
ER111CS71S08	mm. 8														
ER111CS71S10	mm. 10														
ER111CS71S12	mm. 12														



 <p>Piedino 2 aghi con suola aperta cl. 112W, 112W, 212G, 212U, 212W Anche per macchine Juki cl. LH 512, 515, Consew, Seiko, Brother</p>	Codice	Misura		Codice	Misura		
	ER111CS23799	1/8"	mm. 3,2				
	ER111CS23800	3/16"	mm. 4,8	ER111CS24084	5/8"	mm.15,9	
	ER111CS24062	.1/4"	mm. 6,4	ER111CS23771	.3/4"	mm.19,0	
	ER111CS24063	9/32"	mm. 7,2	ER111CS24133	7/8"	mm.22,2	
	ER111CS24064	5/16"	mm. 8,0	ER111CS24068	1"	mm.25,4	
	ER111CS24080	3/8"	mm. 9,5	ER111CS24086	1,1/8"	mm.28,6	
	ER111CS24081	7/16"	mm.11,0	ER111CS24088	1,1/4"	mm.31,8	
	ER111CS24082	.1/2"	mm.12,5	ER111CS24089	1,3/8"	mm.34,9	
	ER111CS24083	9/16"	mm.14,3	ER111CS24078	1,1/2"	mm.37,9	
 <p>Piedino 2 aghi con suola chiusa cl. 112W, 112W, 212G, 212U, 212W Anche per macchine Juki cl. LH 512, 515, Consew, Seiko, Brother</p>	Codice	Misura		Codice	Misura		
	ER111CS24127	1/16"	mm. 2,1	ER111CS23766	1/2"	mm.12,5	
	ER111CS24158	3/32"	mm. 2,4	ER111CS23767	9/16"	mm.14,3	
	ER111CS24159	1/8"	mm. 3,2	ER111CS23768	5/8"	mm.15,9	
	ER111CS24160	5/32"	mm. 4,0	ER111CS23769	3/4"	mm.19,0	
	ER111CS24161	3/16"	mm. 4,8	ER111CS23770	7/8"	mm.22,2	
	ER111CS23759	7/32"	mm. 5,6	ER111CS23772	1"	mm.25,4	
	ER111CS23760	1/4"	mm. 6,4	ER111CS23773	1,1/8"	mm.28,6	
	ER111CS23761	9/32"	mm. 7,2	ER111CS23774	1,1/4"	mm.31,8	
	ER111CS23762	5/16"	mm. 8,0	ER111CS23775	1,3/8"	mm.34,9	
	ER111CS23763	11/32"	mm. 8,7	ER111CS23776	1,1/2"	mm.37,9	
	ER111CS23764	3/8"	mm. 9,5	ER111CS23777	1,5/8"	mm.41,3	
	ER111CS23765	7/16"	mm.11,0	ER111CS23778	1;3/4"	mm.44,4	
	 <p>Piedino 2 aghi con guida mobile destra cl. 112W, 112W, 212G, 212U, 212W Anche per macchine Juki , Consew, Seiko, Brother</p>	Codice		Misura			
Guida mm.1,6							
ER111CS57018		1/8"		mm. 3,2			
ER111CS57036		3/16"		mm. 4,8			
ER111CS57014		1/4"		mm. 6,4			
ER111CS57056		5/16"		mm. 8,0			
ER111CS57038		3/8"		mm. 9,5			
Guida mm. 0,8							
ER111C000205		1/8"		mm. 3,2			
ER111C000206		3/16"		mm. 4,8			
ER111C000207		1/4"		mm. 6,4			
ER111C000208		5/16"		mm. 8,0			
ER111C000209		3/8"		mm. 9,5			
 <p>Piedino 2 aghi con guida mobile doppia cl. 112W, 112W, 212G, 212U, 212W Anche per macchine Juki , Consew, Seiko, Brother</p>		Codice		Misura			
	Guida mm.1,6						
	ER111CS57D18		1/8"		mm. 3,2		
	ER111CS57D36		3/16"		mm. 4,8		
	ER111CS57D14		1/4"		mm. 6,4		
	ER111CS57D56		5/16"		mm. 8,0		
	ER111CS57D38		3/8"		mm. 9,5		
	Guida mm. 0,8						
	ER111CS57G18		1/8"		mm. 3,2		
	ER111CS57G36		3/16"		mm. 4,8		
	ER111CS57G14		1/4"		mm. 6,4		
	ER111CS57G56		5/16"		mm. 8,0		
	ER111CS57G38		3/8"		mm. 9,5		
		ER111CS25918	1/8"		2 aghi per cerniere		
ER111CS25936		3/16"		259635 cl. 112W140			
ER111CS25914		1/4"					

PIEDINI PER SINGER, DURKOPP, JUKI

							
ER111CS40148 240148	ER111CS40149 240149	ER111CS40135 240135	ER111CS40158 240158	ER111CS0158S 240158SSP			
							
ER111CS0148H 240148H pesante	ER111CS0149H 240149H pesante	ER111CS40130 240130	ER111CS40154 240154	ER111CS40517 240517	ER111CS40518 240518		
							
ER111CS40128 240128	ER111CS40150 240150	ER111CS40551 240551	ER111CS40552 240552	ER111CS40133 240133	ER111CS40153 240153		
	Codice	Originale	Misura		Codice	Originale	Misura
	ER111CS31018	S 31	1/8		ER111CS30018	S 30	1/8
	ER111CS31316	S 31	3/16		ER111CS30316	S 30	3/16
	ER111CS31014	S 31	1/4		ER111CS30014	S 30	1/4
	ER111CS31516	S 31	5/16		ER111CS30516	S 30	5/16
	Codice	Originale	Misura		Codice	Originale	Misura
	ER111CS40761	240761	1/8		ER111CS40762	240762	1/8
	ER111CS40548	240548	3/16		ER111CS40549	240549	3/16
	ER111CS40370	240370	1/4		ER111CS40371	240371	1/4
	ER111CS40781	240781	5/16		ER111CS40782	240782	5/16
	Codice	Originale	Misura		Codice	Originale	Misura
	ER111CS40567	240567	3/16		ER111CS40569	240569	3/16
	ER111CS40570	240570	1/4		ER111CS40568	240568	1/4
	ER111CS40134	240134	5/16		ER111CS40157	240157	5/16

	Codice	Originale	Misura		Codice	Originale	Misura
	ER111CS0779N	240779NS	3/16		ER111CS0780N	240780NS	3/16
	ER111CS0370N	240370NS	1/4		ER111CS0371N	240371NS	1/4
	ER111CS0781N	240781NS	5/16		ER111CS0782N	240782NS	5/16
	Codice	Originale	Misura		Codice	Originale	Misura
	ER111CS17018	237178	1/8"		ER111CS18018	237187	1/8"
	ER111CS17316	237178	3/16"		ER111CS18316	237187	3/16"
	ER111CS17014	237178	1/4"		ER111CS18014	237187	1/4"
	ER111CS17516	237178	5/16"		ER111CS18516	237187	5/16"
	ER111CS17038	237178	3/8"		ER111CS18038	237187	3/8"
	ER111CS17012	237178	1/2"		ER111CS18012	237187	1/2"
	ER111CS17034	237178	3/4"		ER111CS18034	237187	3/4"
	Codice	Originale	Misura		Codice	Originale	Misura
	ER111CS94316	S 94	3/16"		ER111CS93316	S 93	3/16"
	ER111CS94014	S 94	1/4"		ER111CS93014	S 93	1/4"
	ER111CS94516	S 94	5/16"		ER111CS93516	S 93	5/16"

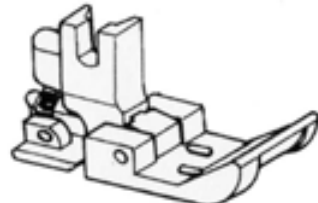
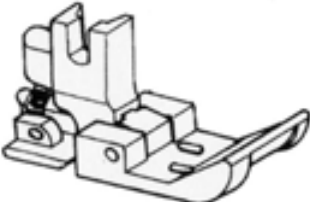
cl. 231

					
Codice	Originale	Misura	Codice	Originale	Misura
110CS39245	139245	3/16"	110CS61316	146615	3/16"
110CS39246	139145	1/4"	110CS61014	146615	1/4"
					
Codice	Originale	Misura	Codice	Originale	Misura
110C000124	139138	3/16"	110CS39405	139405	
110C000125	139138	1/4"			