

PARTI PER LEWIS

Cl. 150



ER104C000622
36-16

Cl. 160



ER110CL11976
119-76



ER110CL12242
122-42 (119-85)



ER110CL01015
1015



ER110CL00665
6-65



ER110CL01016
1016



ER104C000612
36-19



ER110CL45398
445-398



ER110CL26171
26-171



ER110CL03464
34-4



ER110CL45348
45-348



ER110CL08126
8-126

Cl. 200



ER110CL02034
20-34



ER110CL18747
18-747



ER110CL20128
20-128



ER110CL21416
21-416



ER110CL20127
20-127



ER110CL07192
71-92



ER110CL45434
45-434



ER110CL12229
12-229 (122-58)



ER110CL18982
18-982



ER110CL45302
45-302























ER110CL65216
652-16











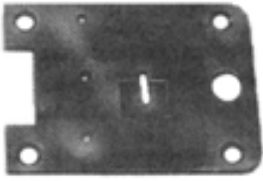





























ER110CL40190
40-190













Cl. 200

 ER110CL18959 18-959	 ER110CL16607 166-7	 ER110CL05120 51-20	 ER110CL44280 44-280	 ER110CL26163 26-163	
 ER110CL22266 22-266	 ER110CL21360 21-360	 ER110CL01802 180-02	 ER110CS0G104 EG104		
 ER110CL45432 445-432	 ER110CL44288 44-288	 ER110CL44298 445-298	 ER110CI45839 458-39		
 ER110CL65216 652-16	 ER110CL22266 22-266	 ER110CL21229 21-229	 ER110CL21360 21-360		
 ER110CL22224 22-224	 ER110CL02511 25-11 Barra ago			ER110CL18272 18-272 Vite ago	
 ER110CL24308 24-308	 ER110CL99338 99-313 18			ER110CL99330 99-313 20	ER110CL99332 99-313 22

Cl. 200

 ER110CL10204 110-204		 ER110CL43075 430-75				 ER110CL18318 18-318 Vite		 ER110CL12245 122-45 Scartafilo		
 ER110CLT175 T 1Q75		 ER110CL75392 175392	 ER110CL75393 175393	 ER110CL75398 175398	 ER110CL75399 175399					
 ER110CL75676 175676	 ER110CLSM526 SM526 Magnetico	 ER110CL75890 175890 ER110CL75889 175889 Molla	 ER110CL175SB 175 SB	 ER110CL00501 501 Regolabile	 ER110CL00502 502 Regolabile					
 ER110CL49049 490-49		 ER110CL08132 8-132 Molla		 ER110CL20020 200-20		 ER110CL0073A 73 A Vite		 ER110CL16220 162-20 Molla inferiore		
VITI										
 ER110CL01875 18-75	 ER110CL18125 18-125	 ER110CL18246 18-246	 ER110CL18272 18-272	 ER110CL18307 18-307	 ER110CL18318 18-318					
 ER110CL18558 18-558	 ER110CL18609 18-609	 ER110CL18623 18-623	 ER110CL18733 18-733	 ER110CL18747 18-747	 ER110CL18750 18-750					
 ER110CL18873 18-873	 ER110CL18901 18-901	 ER110CL18929 18-929	 ER110CL18930 18-930	 ER110CL18931 18-931	 ER110CL18959 18-959					

VITI

					
ER110CL18965 18-965	ER110CL18967 18-967	ER110CL18974 18-974	ER110CL0073A 73 A	ER110CL1005L 1005L	ER110CL1039L 1039L
					
ER110CL1046L 1046L	ER110CL1189L 1189L	ER110CL1351L 1351L	ER110CL1776L 1776L	ER110CLCS327 CS 327	ER110CLSBW15 SBW15

PINZE PER LEWIS

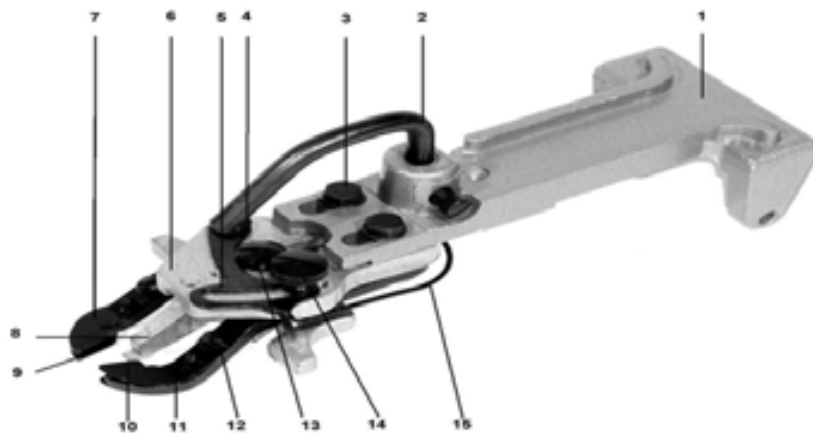

ER110CL43636

Pinza bottoni piatti cpl. linea 20~45 mm. 6/29 430-63-6

N.	Codice	Originale	Descrizione
1	ER110CL99270	99-270	Supporto
2	ER110CL07172	71-72	Leva
3	ER110CL18873	18-873	Vite
4	ER110CL01875	18-75	Vite
5	ER110CL45332	45-332	Leva di stop
6	ER110CL99316	99-316	Supporto
7	ER110CL45347	45-347	Pinza sinistra
8	ER110CL15811	158-11	Indice centr.
9	ER110CL21337	21-337	Molla sinistra
10	ER110CL21336	21-336	Molla destra
11	ER110CL45346	45-346	Pinza destra
12	ER110CL1189L	1189L	Vite
13	ER110CL18931	18-931	Vite
14	ER110CL18945	18-945	Vite
15	ER110CL21315	21-315	Molla

PINZE PER LEWIS



ER110CL4363S

Pinza bottoni piatti grande cpl. linea 40~80 mm. 25/50 430-63-6LS

Pos.	Codice	Originale	Descrizione
1	ER110CL2137S	21-337LS	Molla sinistra
2	ER110CL4537S	45-347LS	Pinza sinistra
3	ER110CL1581S	158-11LS	Indice centrale
4	ER110CL4536S	45-346LS	Pinza destra
5	ER110CL2136S	21-336LS	Molla destra

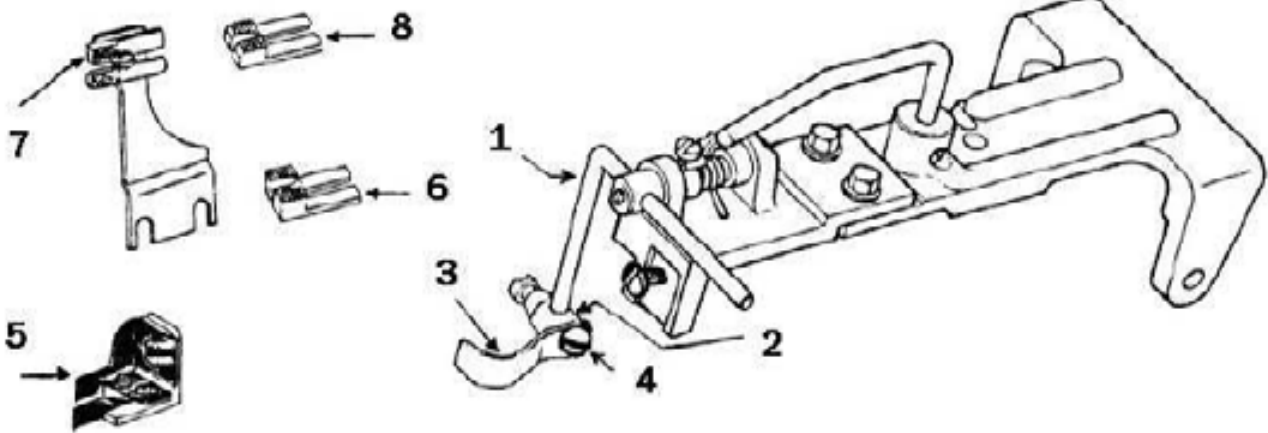

ER110CL43901

Pinza bottoni con gambo completa 430-57-1

N.	Codice	Originale	Descrizione	N.	Codice	Originale	Descrizione
1	ER110CL45468	45-468	Supporto	5	ER110CL20020	200-20	Bottone arresto
2	ER110CL03090	30-90	Supporto	6	ER110CL1513N	115-133N	Blocchetto alto
3	ER110CL99347	99-347	Molla	7	ER110CL1515N	115-125N	Blocchetto medio
4	ER110CL18974	18-974	Vite	8	ER110CL1518N	115-128N	Blocchetto basso

PINZE PER LEWIS

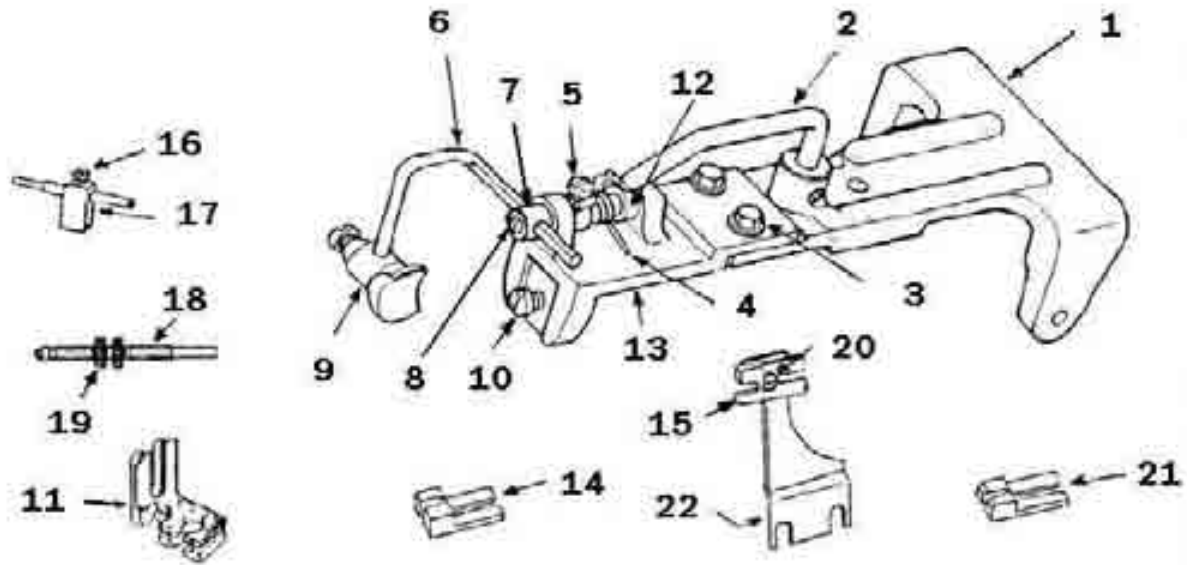

ER110CL43571

Pinza bottoni con gambo completa 430-57-1

N.	Codice	Originale	Descrizione	N.	Codice	Originale	Descrizione
1	ER110CL99308	99-308	Supporto	12	ER110CL03995	39-95	Anello
2	ER110CL07172	71-72	Leva	13	ER110CL50238	50-238	Supporto
3	ER110CL18873	18-873	Vite	14	ER110CL15133	115-133	Blocchetto alto
4	ER110CL21353	21-353	Molla	15	ER110CL15125	115-125	Blocchetto medio
5	ER110CL18623	18-623	Vite	16	ER110CL18750	18-750	Vite
6	ER110CL45372	45-372	Supporto	17	ER110CL15127	115-127	Supporto
7	ER110CL1445L	14-455L	Supporto	18	ER110CL18965	18-965	Regolo
8	ER110CL18733	18-733	Vite	19	ER110CL02060	20-60	Anello
9	ER110CL43055	430-55	Fermo	20	ER110CL18307	18-307	Vite
10	ER110CLCS327	CS-327	Vite	21	ER110CL15128	115-128	Blocchetto basso
11	ER110CL49049	490-49	Stop bottone	22	ER110CL24281	24-281	Piedino