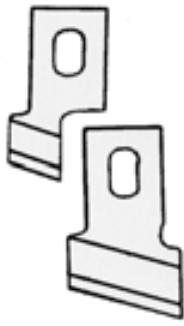

**CI. LBH-760 / 780 / 790**

					
<b>ER104C000048</b> B1808-761-0AO DP2-NJ <b>Cl. 760</b>	<b>ER104C000198</b> B1810-761-0AO Normale <b>Cl. 760</b>	<b>ER104C000199</b> B1810-761-0BA Frizionata <b>Cl. 760</b>	<b>ER104C000101</b> B1808-771-0AO DP2-NJ771 <b>Cl. 780</b>	<b>ER104C000215</b> B1810-771-0AO Normale <b>Cl. 780</b>	<b>ER104C000216</b> B1810-771-0BA Frizionata <b>Cl. 780</b>
					
<b>ER104C000110</b> 137-29058 P2-NJ(790) <b>Cl. 790</b>	<b>ER104C000209</b> 137-29769 Frizionata <b>Cl. 790</b>	<b>ER104C000358</b> B1809-761-000 Alluminio (x tutte)	<b>ER110CJ12761</b> B3112-761-000 Molla tendifilo	<b>ER110CJ2607A</b> B2607-232-0AO	<b>ER110CJ12231</b> B1223-771-000
					
<b>ER110CJ02761</b> B2402-761-000 <b>Cl. 761</b> <b>ER110CJ24022</b> B2402-762-000 <b>Cl. 762</b> <b>ER110CJ24023</b> B2402-763-000 <b>Cl. 763</b>	<b>ER110CJ02771</b> B2402-771-000 <b>Cl. 781/782/783</b> <b>ER110CJ02771</b> B2402-774-000 <b>Cl. 784</b>	<b>ER110CJ12082</b> B1208-232-000 <b>Cl. 760</b> <b>ER110CJ12081</b> B1208-771-000 <b>Cl. 780</b>	<b>ER110CJ12112</b> B1211-232-000 <b>Cl. 760</b> <b>ER110CJ12311</b> B1231-771-000 <b>Cl. 780</b>	<b>ER110CJ3131A</b> B3130-761-000A Salvadito	

	Pos	Codice	Originale	Descrizione
	1	<b>ER110CJ14511</b>	B1451-761-000	Guida filo
	2	<b>ER110CJS751S</b>	SS-7080510-TP	Vite ago
	3	<b>ER110CJ14011</b>	B1401-761-000	<b>Barra ago</b>

**COLTELLI NORMALI**

	Codice	mm.	Inch
	<b>ER106C000522</b>	6,4	.1/4"
	<b>ER106C000523</b>	9,5	3/8
	<b>ER106C000524</b>	11,0	7/16
	<b>ER106C000525</b>	12,5	.1/2
	<b>ER106C000526</b>	14,3	9/16
	<b>ER106C000527</b>	16,0	5/8
	<b>ER106C000528</b>	17,5	11/16
	<b>ER106C000529</b>	19,0	.3/4
	<b>ER106C000530</b>	22,2	7/8
	<b>ER106C000531</b>	25,4	1
	<b>ER106C000532</b>	27,0	1.1/16
	<b>ER106C000533</b>	28,5	1.1/8
	<b>ER106C000534</b>	32,0	1.1/4



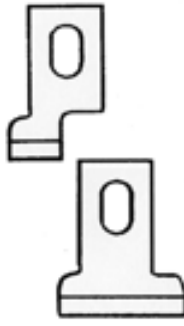



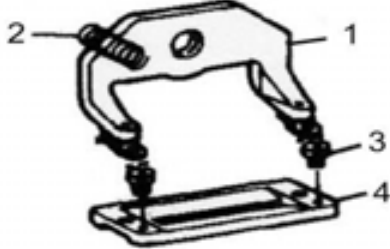
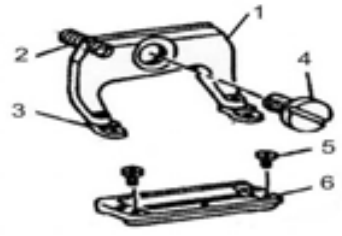

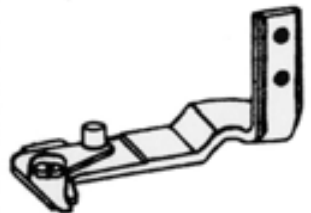
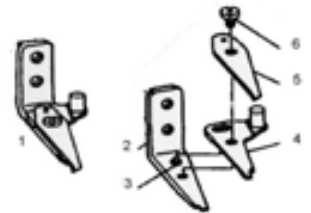

**COLTELLI TAGLIO PIATTO**

	Codice	mm.	Inch
	<b>ER106C000560</b>	6,4	.1/4"
	<b>ER106C000561</b>	9,5	3/8
	<b>ER106C000562</b>	11,0	7/16
	<b>ER106C000563</b>	12,5	.1/2
	<b>ER106C000564</b>	14,3	9/16
	<b>ER106C000565</b>	16,0	5/8
	<b>ER106C000566</b>	17,5	11/16
	<b>ER106C000567</b>	19,0	.3/4
	<b>ER106C000568</b>	22,2	7/8
	<b>ER106C000569</b>	25,4	1
	<b>ER106C000570</b>	27,0	1.1/16
	<b>ER106C000571</b>	28,5	1.1/8
	<b>ER106C000572</b>	32,0	1.1/4

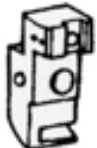
Cl. LBH-760 / 780 / 790 (segue)

 <p>cl. 760</p>				 <p>cl. 780/790</p>			
Pos	Codice	Originale	Descrizione	Pos	Codice	Originale	Descrizione
1	ER110CJ15111	B1511-761-0A0	Supp. cl.761	1	ER110CJ15116	B1511-771-0A0	Supp. cl. 771, 781
1	ER110CJ15112	B1511-762-0A0	Supp. cl.762	1	ER110CJ15117	B1511-772-0A0	Supp. cl. 772, 782
1	ER110CJ15113	B1511-763-0A0	Supp. cl.763	1	ER110CJ15118	B1511-773-0A0	Supp. cl. 773, 783
				1	ER110CJ15119	B1511-774-0A0	Supp. cl. 774, 784
2	ER110CJ15126	B1512-761-000	Molla	2	ER110CJ15126	B1512-761-000	Molla
3	ER110CJS606S	SS-6060210-SP	Vite	3	ER110CJ15096	B1509-761-000	Linguetta
				4	ER110CJSD07P	SD-0790203-SP	Vite
				5	ER110CJS606S	SS-6060210-SP	Vite
4	ER110CJ15081	B1508-761-000	Suola cl. 761	6	ER110CJ15521	B1522-781-000	Suola cl. 771, 781
4	ER110CJ15082	B1508-762-000	Suola cl. 762	6	ER110CJ15522	B1522-782-000	Suola cl. 772, 782
4	ER110CJ15083	B1508-763-000	Suola cl. 763	6	ER110CJ15523	B1522-783-000	Suola cl. 773, 783
				6	ER110CJ15524	B1522-784-000	Suola cl. 774, 784

 <p>cl. 760</p>			 <p>cl. 780</p>			
Codice	Originale	Descrizione	Pos	Codice	Originale	Descrizione
ER106CJ0161A	B2001-761-0A0	Rasafilo cl. 761	1	ER106CJ0171A	B2001-771-0A0	Rasafilo
ER106CJ0162A	B2001-762-0A0	Rasafilo cl. 762	2	ER106CJ20017	B2001-771-000	Lama inferiore
ER106CJ0163A	B2001-763-0A0	Rasafilo cl. 763	3	ER110CJ20056	B2005-761-000	Perno
			4	ER106CJ20027	B2002-771-0A0	Lama superiore
			5	ER110CJ20037	B2003-771-000	Molla
			6	ER110CJSD40T	SD-0400191-TP	Vite

 <b>ER106CJ24801</b> B2408-761-000 Coltello cl. 760	 <b>ER106CJ24061</b> B2406-761-0A0 Coltello cl. 760	 <b>ER110CJ20031</b> B2003-761-000 cl. 760	 <b>ER110CJ24056</b> B2405-761-000 cl. 760	 <b>ER110CJ14057</b> B1405-771-000	 <b>ER110CJ15201</b> B1502-771-00A Blocchetto
 <b>ER110CJ15041</b> B1504-771-000 Bussola	 <b>ER110CJ15031</b> B1503-771-00A0 Perno	 <b>ER106CJ20311</b> B2031-771-000 Sfera	 <b>ER110CJ2424A</b> B2424-771-000A	 <b>ER110CJ24161</b> B2416-771-000	

CI. LBH-760 / 780 / 790 (segue)

					
ER110CJ24171 B2417-771-000 cl.780	ER110CJ24051 B2405-771-000 cl.780	ER110CJ20321 B2032-771-000 Morsetto	ER110CJS710S SS-7110840-SP Vite	ER106CJ08771 B2408-771-000 Coltello cl.780	
					
ER110CJ24041 B2404-771-000	ER110CJ27301 B2730-761-000	ER110CJ24261 B2426-771-000	ER110CJ24211 B2421-771-000	ER110CJ24251 B2425-771-000	
					
ER110CJ27171 B2717-761-000	ER110CJ27311 B2731-761-000	ER110CJ27011 B2701-761-000	ER110CJ27091 B2709-771-000	ER110CJ29141 B2914-761-000	
					
ER110CJ27101 B2710-771-000	ER110CJ27261 B2726-761-000	ER110CJ27181 B2718-761-000	ER110CJ27251 B2725-761-000	ER110CJ27271 B2727-761-000	
					
ER110CJ11110 B1111-232-000 ER110CJS715S SS-7151210-SP Vite	ER110CJ31091 B3109-761-000 ER110CJS719S SS-7110910-SP Vite	ER110CJ11265 B1126-552-000 ER110CJS707S SS-7090710-SP Vite	ER110CJ31151 B3115-761-000 ER110CJS710S SS-7110840-SP Vite	ER110CJ31181 B3118-771-000	
					
ER110CJ31141 B3114-771-000					
					
ER110CJ34041 B3404-771-000	ER110CJ34031 B3403-761-000	ER110CJ31041 B3104-771-000			

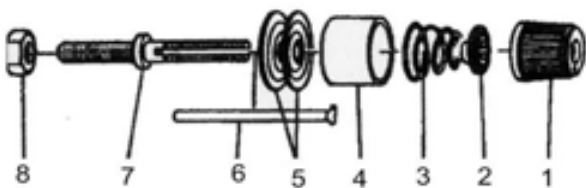

Pos	Codice	Originale	Descrizione
1	ER110CJ96703	119-56703	Pomello
2	ER110CJ20172	B2017-372-000	Ghiera
3	ER110CJ20172	B2017-372-000	Molla
4	ER110CJ31078	B3107-804-000	disco
5	ER110CJ31262	B3126-012-000	Piattello
6	ER110CJ31036	B3103-761-000	Perno
7	ER110CJ20192	B2019-372-000	Perno tensione
8	ER110CJN616P	NS-6160520-SP	Dado

<b>Completa</b>	
Codice	Originale
ER110CJ3103A	B3103-771-0A0

CI. LBH-760 / 780 / 790 (segue)

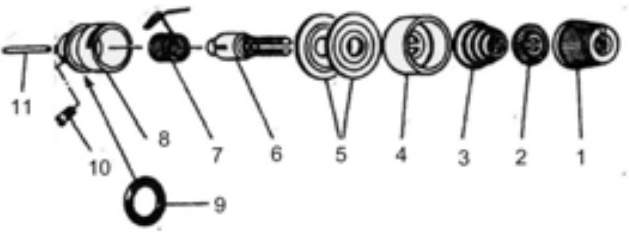

	Pos	Codice	Originale	Descrizione
	1	ER110CJ96703	119-56703	Pomello
	2	ER110CJ31010	B3101-804-000	Ghiera
	3	ER110CJ31124	B3112-704-000	Molla
	4	ER110CJ31262	B3126-012-000	Disco
	5	ER110CJ31078	B3107-804-000	Piattello
	6	ER110CJ31117	B3111-761-000	Perno tensione
	7	ER110CJ12761	B3112-761-000	<b>Molla tendifilo</b>
	8	ER110CJ31107	B3110-771-000	Porta tensione
	9	ER110CJRO095	RO-0952001-00	Anello
	10	ER110CJS809S	SS-8090670-SP	Vite
11	ER110CJ3118D	B3118-552-D00	Perno apri ten.	
<b>Completa</b>				
Codice	Originale			
ER110CJ3110A	B3110-771-0A0			

CI. LH-512, 515

 <p>ER104C000074 B1830-512-0A0 HSH-21-40(J)</p>	 <p>ER104C000166 B1830-512-0AH HSH-21-40(AJ) Serie H</p>	 <p>ER104C000361 B9117-051-000 Ferro</p>
--	---	---

CI. LH-512, 515, 1150/1152

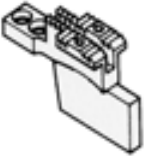
	Codice	Originale	Misura		Codice	Originale	Misura
	ER110CJ24BA0	B1524-512-BA0	1/8"		ER110CJ09B00	B1109-512-B00	1/8"
	ER110CJ24DA0	B1524-512-DA0	3/16"		ER110CJ09D00	B1109-512-D00	3/16"
	ER110CJ24EA0	B1524-512-EA0	7/32"		ER110CJ09E00	B1109-512-E00	7/32"
	ER110CJ24FA0	B1524-512-FA0	.1/4"		ER110CJ09F00	B1109-512-F00	.1/4"
	ER110CJ24HA0	B1524-512-HA0	5/16"		ER110CJ09H00	B1109-512-H00	5/16"
	ER110CJ24KA0	B1524-512-KA0	3/8"		ER110CJ09K00	B1109-512-K00	3/8"
	ER110CJ24LA0	B1524-512-LA0	.1/2"		ER110CJ09L00	B1109-512-L00	.1/2"
	ER110CJ24MA0	B1524-512-MA0	5/8"		ER110CJ09M00	B1109-512-M00	5/8"
	ER110CJ24NA0	B1524-512-NA0	.3/4"		ER110CJ09N00	B1109-512-N00	.3/4"
	ER110CJ24PA0	B1524-512-PA0	7/8"		ER110CJ09P00	B1109-512-P00	7/8"
ER110CJ24QA0	B1524-512-QA0	1"	ER110CJ09Q00	B1109-512-Q00	1"		

	Codice	Originale	Misura		Codice	Originale	Misura
	ER110CJ13B00	B1613-512-B00	1/8"		ER110CJ02B00	B1402-051-B00	1/8"
	ER110CJ13D00	B1613-512-D00	3/16"		ER110CJ02D00	B1402-051-D00	3/16"
	ER110CJ13E00	B1613-512-E00	7/32"		ER110CJ02E00	B1402-051-E00	7/32"
	ER110CJ13F00	B1613-512-F00	.1/4"		ER110CJ02F00	B1402-051-F00	.1/4"
	ER110CJ13H00	B1613-512-H00	5/16"		ER110CJ02H00	B1402-051-H00	5/16"
	ER110CJ13K00	B1613-512-K00	3/8"		ER110CJ02K00	B1402-051-K00	3/8"
	ER110CJ13L00	B1613-512-L00	.1/2"		ER110CJ02L00	B1402-051-L00	.1/2"
	ER110CJ13M00	B1613-512-M00	5/8"		ER110CJ02M00	B1402-051-M00	5/8"
	ER110CJ13N00	B1613-512-N00	.3/4"		ER110CJ02N00	B1402-051-N00	.3/4"
	ER110CJ13P00	B1613-512-P00	7/8"		ER110CJ02P00	B1402-051-P00	7/8"
ER110CJ13Q00	B1613-512-Q00	1"	ER110CJ02Q00	B1402-051-Q00	1"		

CI. LH-1150, 1152, 1162, 1182

 <p>ER104C000168 101-10104 HSH-12(2)</p>	 <p>ER104C000167 101-10062 HSH-12(2)TR</p>	 <p>ER104C000299 101-10252 CP-12(2)</p>	 <p>ER104C000361 B9117-051-000 Cl. 1150, 1152-4, -5</p>
---	---	---	--



Cl. 1152	Cl. 1150, 1152-4, -5	Cl. 1150, 1152-4, -5	
----------	----------------------	----------------------	--



**Cl. LH-1150, 1152, 1162, 1182(segue)**

 <b>ER104C001041</b> 102-08056 Destro HSH-12-62C(R) Cl. LH-1162 <b>ER104C001042</b> 102-07959 Sinistro HSH-12-62C(L) Cl. LH-1162	 <b>ER104C001045</b> 102-07850 Destro HSH-12-62CTR(R) Cl. LH-1162-4, -5 <b>ER104C001046</b> 102-07751 Sinistro HSH-12-62CTR(L) Cl. LH-1162-4, -5	 <b>ER104C001100</b> 101-08254 CP-62C Cl. 1162, 1162-4, -5	 <b>ER104C000361</b> B9117-051-000 Cl. 1162, 1162-4, -5
 <b>ER104C001043</b> 102-31157 Destro HSH-12M-82CTR(R) LH-1182-4, -5 <b>ER104C001044</b> 102-31058 Sinistro HSH-12M-82CTR(L) LH-1182-4, -5	 <b>ER104C001107</b> 102-31553 CP-M82C	 <b>ER106CJ21118</b> 102-21118 Cl. 1152, 1172 <b>ER106CJ21110</b> 102-11100 Cl. 1152, 1172 <b>ER106CJ21605</b> 102-11605 Cl. 1160/62, 1180/82	 <b>ER106CJ21209</b> 102-11209 Cl. 1152 <b>ER106CJ22403</b> 102-32403 Cl. 1172, 1180

**Cl. LK-280, 980, 1850,1900**

 <b>ER104C000210</b> B1828-980-0A0 Capsula	 <b>ER104C000324</b> B1827-280-A00 Spolina	 <b>ER104C000175</b> B1818-280-00 HLK-280	 <b>ER110CJ1817A</b> B1817-280-0A0	 <b>ER110CJ1812A</b> B1812-980-0A0	 <b>ER110CJS612P</b> SS-6121212-TP Vite
 <b>ER110CJ18150</b> B1815-980-000	 <b>ER110CJ791H</b> CS-0791016-SH Anello	 <b>ER110CJS811P</b> SS-8110520-TP Vite	 <b>ER110CJ14040</b> B1404-280-000 Biella	 <b>ER110CJ12030</b> B1203-280-000 Biella	 <b>ER110CJ1901A</b> B1901-280-0A0 Gr. tendifilo
 <b>ER110CJ19040</b> B1904-280-000 Perno	 <b>ER110CJ57501</b> 135-37501 Blocchetto	 <b>ER110CJ26052</b> B2605-372-000 Vite	 <b>ER110CJ25480</b> B2548-280-000	 <b>ER110CJ56702</b> 135-26702	
 <b>ER110CJ11248</b> B1124-280-000 Passafilo	 <b>ER110CJ11110</b> B1111-232-000 Passafilo	 <b>ER110CJS715S</b> SS-7151210-SP Vite	 <b>ER110CJ31141</b> B3114-771-000 Passafilo	 <b>ER110CJ11265</b> B1126-552-000 Passafilo	 <b>ER110CJS707S</b> SS-7090710-SP Vite

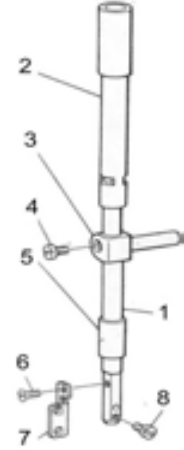
Cl. LK-280, 980, 1850,1900(segue)

	 <p><b>ER110CJ31018</b> B3101-280-0A0 Protezione occhi completa</p>	Pos.	Codice	Originale	Descrizione
		1	<b>ER110CJ14010</b>	B1401-280-000	<b>Barra ago</b>
		2	<b>ER110CJ14020</b>	B1402-280-000	Boccola sup.
		3	<b>ER110CJ14112</b>	B1411-552-000	Morsetto
		4	<b>ER110CJS609T</b>	SS-6090670-TP	Vite
		5	<b>ER110CJ14030</b>	B1403-280-000	Boccola inf.
		6	<b>ER110CJS251S</b>	SS-2060510-SP	Vite
		7	<b>ER110CJ14050</b>	B1405-280-000	Passafilo
		8	<b>ER110CJS604S</b>	SS-6080340-SP	Vite

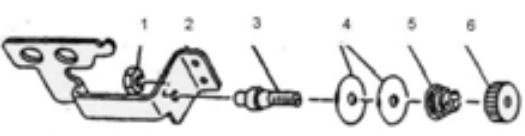
 <p>Tensione filarello</p>	Pos	Codice	Originale	Descrizione
	1	<b>ER110CJN611P</b>	NS-6110310-SP	Dado
	2	<b>ER110CJ56801</b>	135-26801	Supporto
	3	<b>ER110CJ32190</b>	B3219-232-000	Perno tensione
	4	<b>ER110CJ32140</b>	B3214-047-000	Piattello
	5	<b>ER110CJ32180</b>	B3218-232-000	Molla
6	<b>ER110CJ32160</b>	B3216-047-000	Pomello	

 <p>Tensione pimo filo</p>	Pos	Codice	Originale	Descrizione
	1	<b>ER110CJ31230</b>	B3123-352-000	Dado
	2	<b>ER110CJ31262</b>	B3126-012-000	Supporto
	3	<b>ER110CJ11150</b>	B1115-232-000	Molla TV
	3	<b>ER110CJ31291</b>	B3129-771-000	Molla TN
4	<b>ER110CJ31250</b>	B3125-012-000	Pomello	

 <p>Tensione secondo filo</p>	Pos	Codice	Originale	Descrizione
	14	<b>ER110CJ31191</b>	B3119-771-000	Pomello
	13	<b>ER110CJ31205</b>	B3120-125-000	Ghiera
	12	<b>ER110CJ31142</b>	B3114-232-000	Molla
	11	<b>ER110CJ31078</b>	B3107-804-000	Scodella
	10	<b>ER110CJ31322</b>	B3132-552-000	Disco
	9	<b>ER110CJ31262</b>	B3126-012-000	Piattello
	8	<b>ER110CJ12761</b>	B3112-761-000	<b>Molla tendifilo</b>
	7	<b>ER110CJ23020</b>	B2302-280-000	Perno tensione
	6	<b>ER110CJ23130</b>	B2313-280-000	Porta tensione
5	<b>ER110CJS806S</b>	SS-8090610-SP	Grano	





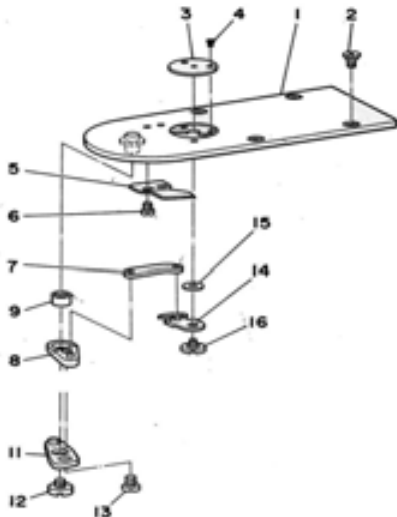

Codice	Originale
<b>ER110CJ2302A</b>	B2302-280-0A0

 <p><b>ER110CJ21020</b> B2102-280-000</p>	 <p><b>ER110CJ21100</b> B2110-280-000</p>	 <p><b>ER110CJ2101A</b> B2101-280-0A0</p>	 <p><b>ER110CJ38809</b> 135-08809</p>	 <p><b>ER110CJ38908</b> 135-08908</p>	 <p><b>ER110CJS611P</b> SS-6111140-SP</p>
 <p><b>ER110CJ12020</b> B1202-280-000 Camme</p>	 <p><b>ER110CJ12088</b> B1208-980-000 Cuscinetto</p>	 <p><b>ER110CJ12118</b> B1211-980-000 Cuscine</p>	 <p><b>ER110CJ12170</b> B1217-280-000 Molla</p>	 <p><b>ER110CJ53750</b> 135-03750</p>	 <p><b>ER110CJ54105</b> 135-04105 Molla</p>

Cl. LK-280, 980, 1850,1900(segue)

					
ER110CJ54402 135-04402	ER110CJ54501 135-04501	ER110CJ54600 135-04600	ER110CJ54006 135-04006 Anello	ER110CJ54907 135-04907 Anello	ER110CJ54303 135-04303 Rondella
					
ER110CJ54709 135-04709	ER110CJ55003 135-05003	ER110CJ12530 B1253-980-000 Sfera	ER106CJ24218 B2421-280-0A0 Coltello (14)	ER106CJ24248 B2424-280-000 Coltello (5)	

	Pos.	Codice	Originale	Descrizione
	1	ER110CJ2425A	B2425-280-0A0	Placca cl. 280
	1	ER110CJ55564	135-26702	Placca cl. 1850
	2	ER110CJS111T	SS-1110640-TP	Vite
	3	ER110CJ24260	B2426-280-000	Guida ago
	4	ER110CJS106P	SS-1060210-TP	Vite
	5		Vedi sopra	Coltello
	6	ER110CJS709P	SS-7090410-SP	Vite
	7	ER110CJ24180	B2418-280-000	Connessione
	8	ER110CJ24150	B2415-280-0A0	Leva piccola
	9	ER110CJ24160	B2416-280-000	Anello
	11	ER110CJ24140	B2414-280-0A0	Leva larga
	12	ER110CJS614T	SS-6110430-TP	Vite
	13	ER110CJS751P	SS-7110510-SP	Vite
			Vedi sopra	Coltello
	15	ER110CJ2423C	B2423-280-00C	Rondella
16	ER110CJSD59P	SD-0500091-TP	Vite	





		
ER110CJ52808 135-42808 Cl. LK.1852-22	ER110CJ52409 135-48409 Cl. LK.1852H-5	ER110CJ58003 135-48003 Cl. LK.1854-24
		
ER110CJ52907 135-42907 Destro ER110CJ53004 135-43004 Sinistro	ER110CJ58508 135-48508 Destro ER110CJ58607 135-48607 Sinistro	ER110CJ58102 135-48102 Destro ER110CJ58201 135-48201 Sinistro

**Cl. LU-53, 55, 562, 563**

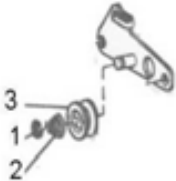
 <b>ER104C000068</b> B1830-055-0A0 HSH-11-15 cl. LU-53, 55-2, -3, 562	 <b>ER104C000064</b> B1830-051-0A0 HSH-12-15 cl. LU-53-7, 562A	 <b>ER104C000171</b> B1808-563-0A0 HSH-12-15MMJ cl. LU-563	 <b>ER104C000170</b> B1830-563-BA0 HSH-12-15MMJ(A) cl. LU-563-3	 <b>ER104C000361</b> B9117-051-000 Ferro
 <b>ER110CJ09562</b> B1109-562-000	 <b>ER110CJ13563</b> B1613-563-000	 <b>ER110CJ13053</b> B1613-053-000	 <b>ER110CJ20051</b> B1820-051-000 Biella	 <b>ER110CJ24563</b> B1824-563-000 Leva capsula
 <b>ER110CJ19053</b> B1419-563-000 Guida filo	 <b>ER110CJ14051</b> B1114-051-000 Passa filo	 <b>ER110CJ01053</b> B1401-0563-000 Barra ago		
 <b>ER110CJ2151A</b> B1821-051-0A0	 <b>ER110CJ66053</b> B1466-053-000 Barra di movimento	 <b>ER110CJ2153A</b> B3121-053-0A0 Gruppo tensione		

**Cl. MB-372, 373**

		Pos.	Codice	Originale	Descrizione
			<b>ER110CJ0937A</b>	B3109-372-0A0	Gr. Tensione
		1	<b>ER110CJRE03K</b>	RE-0300000-KO	Anello elastico
		2	<b>ER110CJ31100</b>	B3110-372-000	Molla tensione
		3	<b>ER110CJ31480</b>	B3148-123-000	Piattelli

 <b>ER110CJ2406A</b> B2406-373-0A0 Coltello <b>ER110CJSD06H</b> SD-0600095-TH Vite	 <b>ER110CJ10373</b> B2410-373-000 Coltello <b>ER110CJS731S</b> SS-7080310-SP Vite	 <b>ER104C000588</b> B1239-372-000 Cl. MB-372 <b>ER104C000589</b> B1239-372-0A0 Cl. MB-373	 <b>ER110CJ37372</b> B1237-372-000 Cl. MB-372	 <b>ER110CJ37373</b> B1237-373-000 Cl. MB-373
---	---	---	---	---

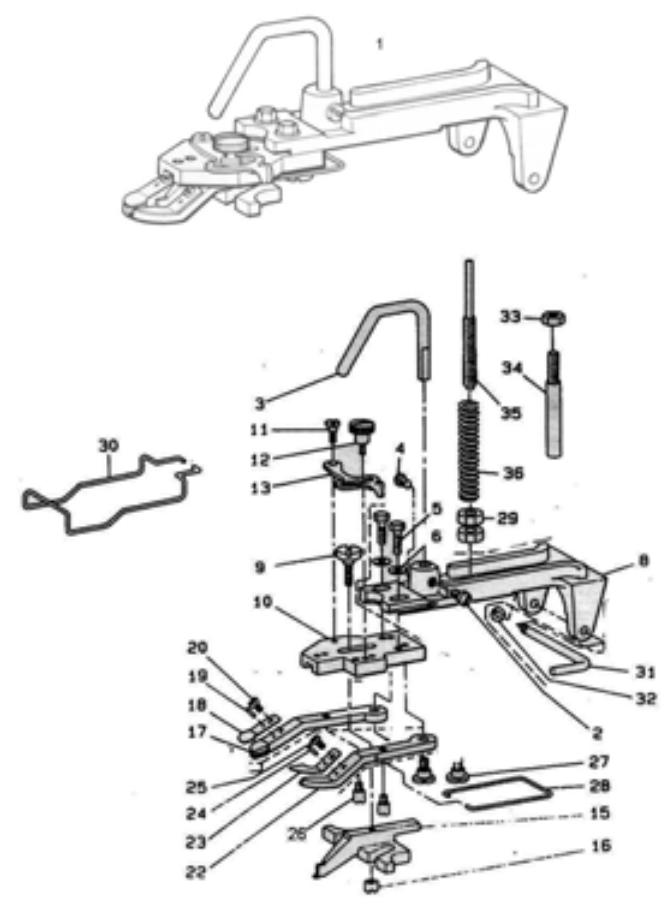

**Cl. MB-372, 373 (segue)**

Codice	Originale	Descrizione	Pos.	Codice	Originale	Descrizione
ER110CJ4737B	B2547-372-0B0	Pinza bottone piatto completa				
			2	ER110CJS715P	SS-7150940-SP	Vite
			3	ER110CJ25462	B2546-372-000	Leva manovra
			4	ER110CJS715P	SS-7150940-SP	Vite
			5	ER110CJS962P	SS-9621413-SP	Vite
			6	ER110CJW050D	WP-0501016-SD	Rondella
			8	ER110CJ25420	B2542-372-000	Gambo
			9	ER110CJSD53P	SD-0550301-SP	Vite
			10	ER110CJ25470	B2547-372-000	Supporto
			11	ER110CJSD51P	SD-0550181-SP	Vite
			12	ER110CJ25490	B2549-372-000	Vite
			13	ER110CJ25482	B2548-372-000	Leva di fermo
			15	ER110CJ25520	B2552-372-000	Guida
			16	ER110CJ25532	B2553-372-000	Dado
			17	ER110CJ25550	B2555-372-000	Leva sinistra
			18	ER110CJ25560	B2556-372-000	Molla sinistra
			19	ER110CJ25590	B2559-372-000	Spina
			20	ER110CJS709P	SS-7090410-SP	Vite
			22	ER110CJ25570	B2557-372-000	Leva destra
			23	ER110CJ25580	B2558-372-000	Molla destra
			24	ER110CJ25590	B2559-372-000	Spina
			25	ER110CJS709P	SS-7090410-SP	Vite
			26	ER110CJ25602	B2560-372-000	Perno di fermo
			27	ER110CJSD64P	SD-0640391-TP	Vite
			28	ER110CJ25610	B2561-372-000	Molla
			29	ER110CJN666P	NS-6660511-SP	Dado
			30	ER110CJ3130A	B3130-372-000A	Salvadita
			31	ER110CJ25402	B2540-372-000	Perno
			32	ER110CJ25410	B2541-372-000	Anello
			33	ER110CJN615P	NS-6150430-SP	Dado
			34	ER110CJ25432	B2543-372-000	Perno di fermo
			35	ER110CJ25440	B2544-372-000	Perno press.
			36	ER110CJ25452	B2545-372-000	Molla

Pos.	Codice	Originale	Descrizione
	ER110CJM6104	MAT-61401ZB0	Completa
<b>Pinza per etichette (Z014/Z044)</b>			
1	ER110CJS506S	SS-5060310-SP	Vite
2	ER110CJM6102	MAT-61402Z00	Molla
3	ER110CJM6101	MAT-61401Z00	Pinza
4	ER110CJM6103	MAT-61403Z00	Fermo
5	ER110CJMAZ14	MAZ-01404000	<b>Placca MB-372</b>
5	ER110CJMAZ44	MAZ-04404000	<b>Placca MB-373</b>

Pos.	Codice	Originale	Descrizione
	ER110CJMZ41A	MAZ-04101-OAO	Completa
<b>Pinza per avvolgigambo lento (Z041)</b>			
1	ER110CJ25490	B2549-372-000	Vite
2	ER110CJMZ411	MAZ-04101-000	Supporto
3	ER110CJMZ413	MAZ-04103-000	Molla
4	ER110CJS508p	SS-5080710-SP	Vite
5	ER110CJMZ412	MAZ-04102-000	Blocchetto
6	ER110CJSD61P	SD-0630301-SP	Vite

**Cl. MB-372, 373 (segue)**

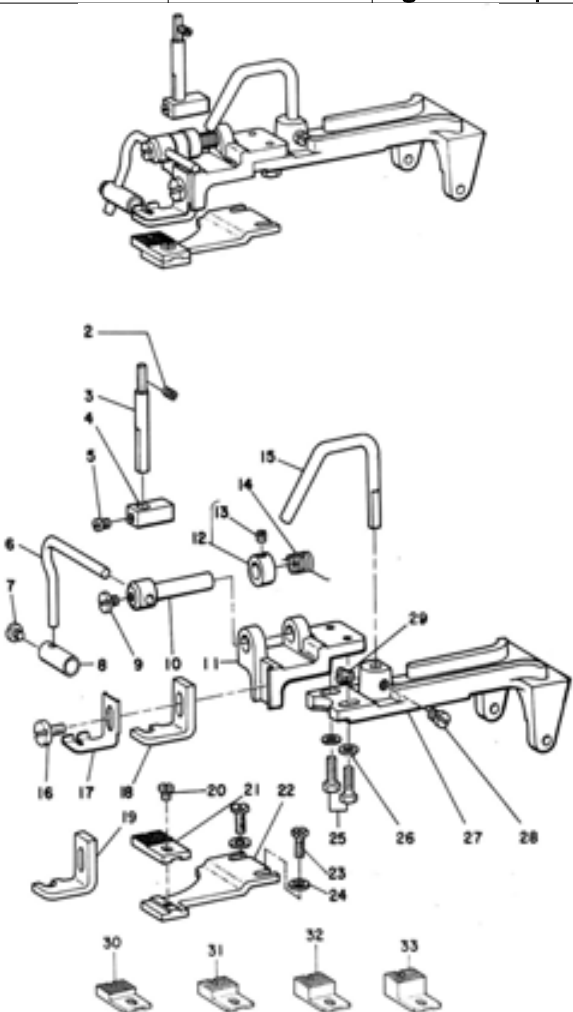
Codice	Originale	Descrizione	Pos.	Codice	Originale	Descrizione			
ER110CJ0137A	B2401-373-0A0	<b>Pinza bottone con gambo completa</b>	2	ER110CJS812P	SS-8120740-SP	Vite			
			3	ER110CJ24110	B2411-372-000	Perno			
			4	ER110CJ24120	B2412-372-000	Blocchetto			
			5	ER110CJS740P	SS-7110540-SP	Vite			
			6	ER110CJ24050	B2405-372-000	Leva			
			7	ER110CJS751P	SS-7110510-SP	Vite			
			8	ER110CJ24060	B2406-372-000	Ferma bottone			
			9	ER110CJS757P	SS-7110570-SP	Vite			
			10	ER110CJ24020	B2402-372-000	Supporto			
			11	ER110CJ24012	B2401-372-000	Supporto			
			12	ER110CJC720P	CS-072081A-SP	Anello			
			13	ER110CJS811T	SS-8110410-TP	Vite			
			14	ER110CJ24040	B2404-372-000	Molla			
			15	ER110CJ25462	B2546-372-000	Leva manovra			
			16	ER110CJS611P	SS-6111140-SP	Vite			
			17	ER110CJ24082	B2408-372-000	Salva bottone			
			18	ER110CJ2419A	B2419-372-A00	Adattatore A			
			19	ER110CJ2419B	B2419-372-B00	Adattatore B			
			20	ER110CJS614P	SS-6110480-SP	Vite			
			21	ER110CJ24100	B2410-372-000	Supporto standard			
			22	ER110CJ24703	B2470-373-000	Placca f			
			23	ER110CJS912P	SS-9120910-TP	Vite			
			24	ER110CJW050D	WP-0501016-SD	Rondella			
			25	ER110CJS962P	SS-9621413-SP	Vite			
			26	ER110CJW050D	WP-0501016-SD	Rondella			
			27	ER110CJ25420	B2542-372-000	Supporto			
			28	ER110CJS715P	SS-7150940-SP	Vite			
			29	ER110CJS715P	SS-7150940-SP	Vite			
			30	ER110CJ2410A	B2410-372-00A	Supporto A			
			31	ER110CJ2410B	B2410-372-00B	Supporto B			
			32	ER110CJ2410C	B2410-372-00C	Supporto C			
			33	ER110CJ2410D	B2410-372-00D	Supporto D			

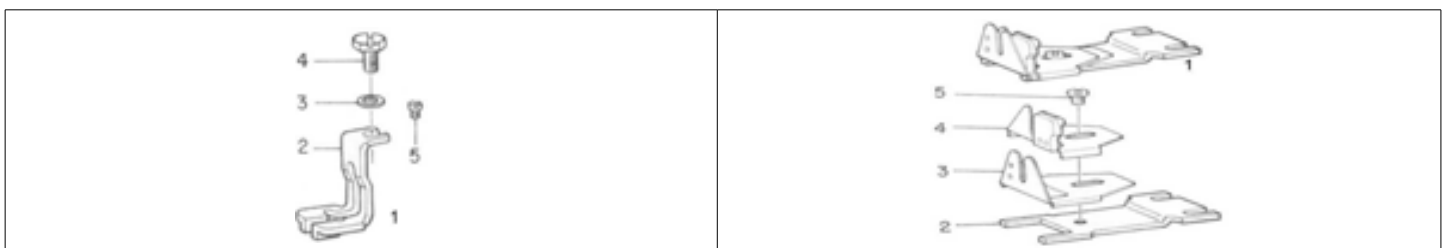

Pos.	Codice	Originale	Descrizione	Pos.	Codice	Originale	Descrizione
1	ER110CJ24472	B2447-732-0A0	Completo	1	ER110CJ2440A	B2440-372-0A0	Completa
<b>I° Pinza per avvolgi gambo (Z004)</b>				<b>II° Pinza per avvolgi gambo (Z005)</b>			
2	ER110CJ24470	B2447-372-000	Pinza	2	ER110CJ24400	B2440-372-000	Placca
3	ER110CJW050D	WP-0501016-SD	Rondella	3	ER110CJ24410	B2441-372-0A0	Guida grande
4	ER110CJS912P	SS-9120910-TP	Vite	4	ER110CJ24420	B2442-372-0A0	Guida media
5	ER110CJ24460	B2446-372-000	Perno	5	ER110CJS911S	SS-9110513-SP	Vite



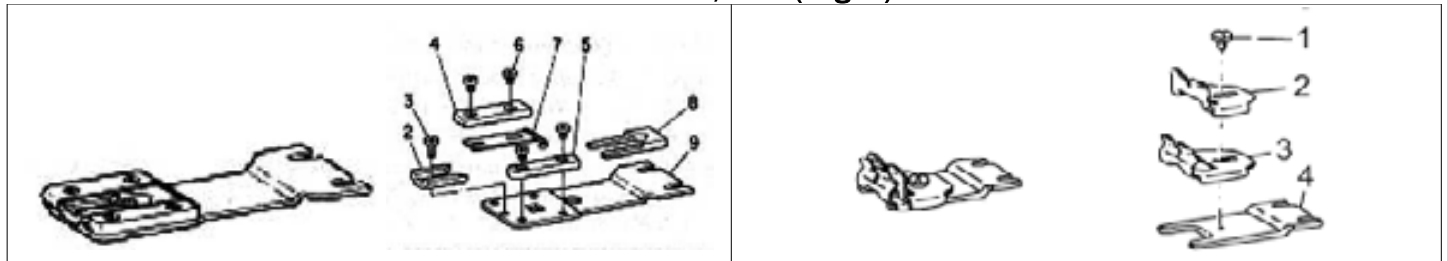



Cl. MB-372, 373 (segue)



Pos.	Codice	Originale	Descrizione	Pos.	Codice	Originale	Descrizione
	<b>ER110CJM639A</b>	MAT-63901-ZA0	MB 373		<b>ER110CJM646A</b>	MAZ-04601-ZA0	MB373
	<b>ER110CJM609A</b>	MAT-60901-ZA0	MB 372		<b>ER110CJM616A</b>	MAT-61601-ZA0	MB372
<b>Pinza per gambo rinforzato (Z009/Z039)</b>				<b>(Z016/Z046)</b>			
2	<b>ER110CJM6395</b>	MAT-63905-Z00	Guida ant.	1	<b>ER110CJS757P</b>	SS-7110570-SP	Vite
3	<b>ER110CJS843S</b>	SS-4080310-SP	Vite	2	<b>ER110CJM6462</b>	MAT-61602-Z00	Guida
4	<b>ER110CJM6393</b>	MAT-63903-Z00	Blocchetto	3	<b>ER110CJM6463</b>	MAT-61603-Z00	Guida
5	<b>ER110CJM6392</b>	MAT-63902-Z00	Blocchetto	4	<b>ER110CJM6461</b>	MAZ-04601-Z00	Placca MB 373
6	<b>ER110CJS608S</b>	SS-6080410-SP	Vite	4	<b>ER110CJM6161</b>	MAT-61601-Z00	Placca MB 372
7	<b>ER110CJMAZ96</b>	MAZ-00906-000	Molla				
8	<b>ER110CJM6394</b>	MAT-63904-Z00	Guida post.	2			
9	<b>ER110CJM6395</b>	MAT-63905-Z00	Placca MB 373	2			
9	<b>ER110CJM6091</b>	MAT-60901-Z00	Placca MB 372				



 <b>ER110CJ11112</b> B111-372-000 Molla	 <b>ER110CJ31032</b> B3103-372-000 Pomello	 <b>ER110CJ3149A</b> B3149-123-A00 Molla	 <b>ER110CJ31040</b> B3104-372-000 Perno	 <b>ER110CJ31073</b> B3107-373-000 Passafilo	 <b>ER110CJ31072</b> B3107-372-000 Passafilo
 <b>ER110CJ31082</b> B3108-372-000 Passafilo	 <b>ER110CJ20372</b> B2037-372-000 Molla	 <b>ER110CJ14072</b> B1407-372-000	 <b>ER110CJ31203</b> B3120-372-0A0 Protezione occhi	 <b>ER110CJ8210A</b> B8210-372-0A0 Porta bottoni	
 <b>ER110CJ12410</b> B1241-372-000 Placca Cl. MB-372	 <b>ER110CJS292T</b> SS-2110920-TP Vite Cl. MB-372	 <b>ER110CJ4137A</b> B1241-373-0A0 Placca Cl. MB-373	 <b>ER110CJS292T</b> SS-2110920-TP Vite Cl. MB-373	 <b>ER110CJ42372</b> B1242-372-000 <b>ER110CJS771S</b> SS-7110710-SP Vite Cl. MB-372	 <b>ER110CJ42373</b> B1242-373-000 <b>ER110CJS771S</b> SS-7110710-SP Vite Cl. MB-373
 <b>ER110CJ20362</b> B2036-372-000 Vite	 <b>ER110CJ20062</b> B2006-372-000 Vite	 <b>ER110CJ20072</b> B2007-372-000 Vite	 <b>ER110CJ20282</b> B2028-372-000 Blocchetto	 <b>ER110CJ20292</b> B2029-372-000 Molla	 <b>ER110CJSD42P</b> SD-0402001-SP Vite



Cl. MB-372, 373 (segue)

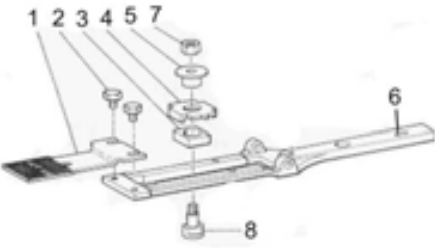



			<b>ER110CJ1230A</b> B1230-372-0A0 Leva cpl.  <b>ER110CJSD64S</b> SD-0640241-SP Vite  <b>ER110CJ12322</b> B1232-372-000 Dado			
<b>ER110CJ20382</b> B2038-372-000 <b>ER110CJS715S</b> SS-7151210-SP Vite	<b>ER110CJ20403</b> B2040-373-000 <b>ER110CJS709S</b> SS-7090510-SP Vite Cl. MB-373			<b>ER110CJ1234A</b> B1234-372-0A0 <b>ER110CJS811T</b> SS-8110410-TP Vite	<b>ER110CJ12272</b> B1227-372-000 <b>ER110CJS815S</b> SS-8151150-SP Vite	<b>ER110CJ12222</b> B1222-372-000 <b>ER110CJS815S</b> SS-8151150-SP Vite

					
<b>ER110CJ2031A</b> B2031-372-0A0 <b>ER110CJSD79S</b> SD-0791271-SP Vite	<b>ER110CJ2537A</b> B2025-372-0A0 <b>ER110CJSD79P</b> SD-0791501-SP Vite	<b>ER110CJ20092</b> B2009-3762-000 Leva apri tens.	<b>ER110CJ25082</b> B2508-372-000	<b>ER110CJ2530A</b> B2530-372-0A0 <b>ER110CJS868P</b> SS-8680810-TP Vite	<b>ER110CJ44192</b> B4419-372-000

	Pos.	Codice	Originale	Descrizione
	1		<b>Vedi sotto</b>	Placca
	2	<b>ER110CJS943T</b>	SS-120643-SP	Vite
	3	<b>ER110CJ25242</b>	B2524-372-000	Blocchetto
	4	<b>ER110CJ25252</b>	B2525-372-000	Lamierino
	5	<b>ER110CJ25262</b>	B2526-372-000	Bussola
	6	<b>ER110CJ25222</b>	B2522-372-000	Piastra
	7	<b>ER110CJN616P</b>	NS-6160520-SP	Dado
	8	<b>ER110CJ25233</b>	B2523373-000	Vite svasata







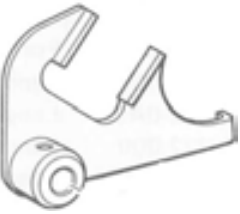

 <p><b>MB-372</b></p>			 <p><b>MB-373</b></p>		
<b>ER110CJ29370</b> B2529-372-000 Standard	<b>ER110CJ2937B</b> B2529-372-B00 Foro Piccolo	<b>ER110CJ2937C</b> B2529-372-C00 Foro Grande	<b>ER110CJ29330</b> B2529-373-000 Standard	<b>ER110CJ2933B</b> B2529-373-B00 Foro Piccolo	<b>ER110CJ2933C</b> B2529-373-C00 Foro Grande

			
<b>ER110CJ44112</b> B4412-372-000A Cl. MB-372	<b>ER110CJ44113</b> B4411-373-000 Cl. MB-373	<b>ER110CJ1201A</b> B1201-372-000 Cl. MB-372	<b>ER110CJ12010</b> B1201-373-000 Cl. MB-373

				
<b>ER110CJ12052</b> B1205-372-000 Molla	<b>ER110CJ12462</b> B1246-372-000 Sfera	<b>ER110CJ12032</b> B1203-372-000 Sfera	<b>ER110CJ1414A</b> B1414-372-0A0 Asta vite	<b>ER110CJ26162</b> B2616-372-000 Molla



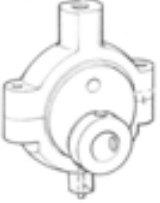
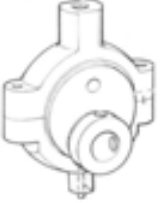

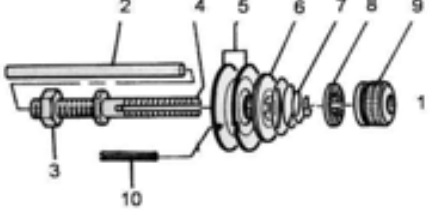
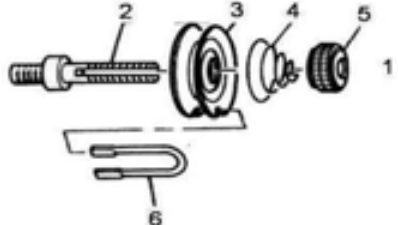

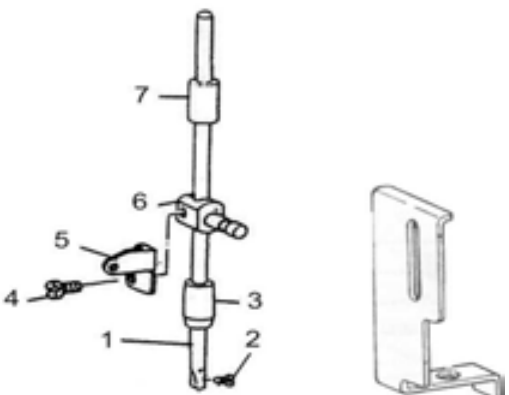

Cl. MB-372, 373 (segue)

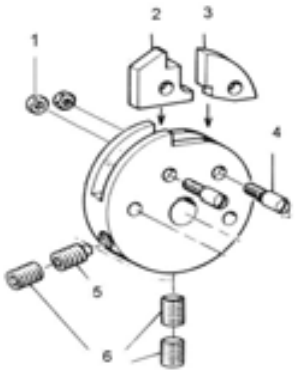
 <p><b>ER110CJ4401A</b> B4401-372-OAO Guida</p>	 <p><b>ER110CJ1217A</b> B1217-372-OAO <b>ER110CJS862T</b> SS-8660612-TP Vite</p>	 <p><b>ER110CJ44162</b> B4416-372-000 Cl. MB-372 <b>ER110CJ44172</b> B4417-372-000 Rullino</p>	 <p><b>ER110CJ44163</b> B4416-373-AA0 Cl. MB-373 <b>ER110CJ44172</b> B4417-372-000 Rullino</p>	 <p><b>ER110CJ12072</b> B1207-372-000 Bussola</p>	 <p><b>ER110CJ1215B</b> B1217-372-OAO Gr.cuscinetto</p>																																																
 <p><b>ER110CJ08372</b> B1208-372-000 Frizione</p>	 <p><b>ER110CJS615P</b> SS-6152440-SP Vite <b>ER110CJW062P</b> WP-0621026-SP Rondella</p>	 <p><b>ER110CJ1416A</b> B1416-372-OAO Gr. snodo</p>	 <p><b>ER110CJ11372</b> B2611-372-000 Leva</p>	 <p><b>ER110CJS817S</b> SS-8151570-SP Vite <b>ER110CJN615S</b> NS-6150310-SP Dado</p>	 <table border="1"> <thead> <tr> <th>Pos</th> <th>Codice</th> <th>Originale</th> <th>Descrizione</th> </tr> </thead> <tbody> <tr> <td>2</td> <td><b>ER110CJ20200</b></td> <td>B2020-372-000</td> <td>Perno</td> </tr> <tr> <td>3</td> <td><b>ER110CJN616P</b></td> <td>NS-6160520-SP</td> <td>Dado</td> </tr> <tr> <td>4</td> <td><b>ER110CJ20192</b></td> <td>B2019-372-000</td> <td>Perno tensione</td> </tr> <tr> <td>5</td> <td><b>ER110CJ20162</b></td> <td>B2016-372-000</td> <td>Piattello</td> </tr> <tr> <td>6</td> <td><b>ER110CJ31321</b></td> <td>B3132-012-000</td> <td>Disco</td> </tr> <tr> <td>7</td> <td><b>ER110CJ31142</b></td> <td>B3114-232-000</td> <td>Molla</td> </tr> <tr> <td>8</td> <td><b>ER110CJ31205</b></td> <td>B3120-125-000</td> <td>Ghiera</td> </tr> <tr> <td>9</td> <td><b>ER110CJ31250</b></td> <td>B3125-012-000</td> <td>Pomello TV</td> </tr> <tr> <td>9</td> <td><b>ER110CJ31165</b></td> <td>B3116-125-000</td> <td>Pomello TN</td> </tr> <tr> <td>10</td> <td><b>ER110CJ20230</b></td> <td>B2023-372-000</td> <td>Spina</td> </tr> </tbody> </table> <table border="1"> <thead> <tr> <th>Codice</th> <th>Originale</th> </tr> </thead> <tbody> <tr> <td><b>ER110CJ2019A</b></td> <td>B2019-372-OAO</td> </tr> </tbody> </table>	Pos	Codice	Originale	Descrizione	2	<b>ER110CJ20200</b>	B2020-372-000	Perno	3	<b>ER110CJN616P</b>	NS-6160520-SP	Dado	4	<b>ER110CJ20192</b>	B2019-372-000	Perno tensione	5	<b>ER110CJ20162</b>	B2016-372-000	Piattello	6	<b>ER110CJ31321</b>	B3132-012-000	Disco	7	<b>ER110CJ31142</b>	B3114-232-000	Molla	8	<b>ER110CJ31205</b>	B3120-125-000	Ghiera	9	<b>ER110CJ31250</b>	B3125-012-000	Pomello TV	9	<b>ER110CJ31165</b>	B3116-125-000	Pomello TN	10	<b>ER110CJ20230</b>	B2023-372-000	Spina	Codice	Originale	<b>ER110CJ2019A</b>	B2019-372-OAO
Pos	Codice	Originale	Descrizione																																																		
2	<b>ER110CJ20200</b>	B2020-372-000	Perno																																																		
3	<b>ER110CJN616P</b>	NS-6160520-SP	Dado																																																		
4	<b>ER110CJ20192</b>	B2019-372-000	Perno tensione																																																		
5	<b>ER110CJ20162</b>	B2016-372-000	Piattello																																																		
6	<b>ER110CJ31321</b>	B3132-012-000	Disco																																																		
7	<b>ER110CJ31142</b>	B3114-232-000	Molla																																																		
8	<b>ER110CJ31205</b>	B3120-125-000	Ghiera																																																		
9	<b>ER110CJ31250</b>	B3125-012-000	Pomello TV																																																		
9	<b>ER110CJ31165</b>	B3116-125-000	Pomello TN																																																		
10	<b>ER110CJ20230</b>	B2023-372-000	Spina																																																		
Codice	Originale																																																				
<b>ER110CJ2019A</b>	B2019-372-OAO																																																				
 <table border="1"> <thead> <tr> <th>Pos</th> <th>Codice</th> <th>Originale</th> <th>Descrizione</th> </tr> </thead> <tbody> <tr> <td>2</td> <td><b>ER110CJ20152</b></td> <td>B2015-372-000</td> <td>Perno tensione</td> </tr> <tr> <td>3</td> <td><b>ER110CJ20162</b></td> <td>B2016-372-000</td> <td>Piattello</td> </tr> <tr> <td>4</td> <td><b>ER110CJ20172</b></td> <td>B2017-372-000</td> <td>Molla tensione</td> </tr> <tr> <td>5</td> <td><b>ER110CJ23149</b></td> <td>B2314-019-000</td> <td>Pomello TV</td> </tr> <tr> <td>5</td> <td><b>ER110CJ31250</b></td> <td>B3125-012-000</td> <td>Pomello TN</td> </tr> <tr> <td>6</td> <td><b>ER110CJ20142</b></td> <td>B2014-372-000</td> <td>Perno guida</td> </tr> </tbody> </table> <table border="1"> <thead> <tr> <th>Codice</th> <th>Originale</th> </tr> </thead> <tbody> <tr> <td><b>ER110CJ2015A</b></td> <td>B2015-372-OAO</td> </tr> </tbody> </table>	Pos	Codice	Originale	Descrizione	2	<b>ER110CJ20152</b>	B2015-372-000	Perno tensione	3	<b>ER110CJ20162</b>	B2016-372-000	Piattello	4	<b>ER110CJ20172</b>	B2017-372-000	Molla tensione	5	<b>ER110CJ23149</b>	B2314-019-000	Pomello TV	5	<b>ER110CJ31250</b>	B3125-012-000	Pomello TN	6	<b>ER110CJ20142</b>	B2014-372-000	Perno guida	Codice	Originale	<b>ER110CJ2015A</b>	B2015-372-OAO	<table border="1"> <thead> <tr> <th>Codice</th> <th>Originale</th> </tr> </thead> <tbody> <tr> <td><b>ER110CJ2015A</b></td> <td>B2015-372-OAO</td> </tr> </tbody> </table>	Codice	Originale	<b>ER110CJ2015A</b>	B2015-372-OAO																
Pos	Codice	Originale	Descrizione																																																		
2	<b>ER110CJ20152</b>	B2015-372-000	Perno tensione																																																		
3	<b>ER110CJ20162</b>	B2016-372-000	Piattello																																																		
4	<b>ER110CJ20172</b>	B2017-372-000	Molla tensione																																																		
5	<b>ER110CJ23149</b>	B2314-019-000	Pomello TV																																																		
5	<b>ER110CJ31250</b>	B3125-012-000	Pomello TN																																																		
6	<b>ER110CJ20142</b>	B2014-372-000	Perno guida																																																		
Codice	Originale																																																				
<b>ER110CJ2015A</b>	B2015-372-OAO																																																				
Codice	Originale																																																				
<b>ER110CJ2015A</b>	B2015-372-OAO																																																				

**Cl. MB-372, 373 (segue)**





	Pos	Codice	Originale	Descrizione
	2	<b>ER110CJS751S</b>	SS-7080510-TP	Vite ago
	3	<b>ER110CJ14032</b>	B1403-372-000A	Boccola inf.
	4	<b>ER110CJS692P</b>	SS-6091210-TP	Vite
	5	<b>ER110CJ31120</b>	B3112-372-000	Bilancere
	6	<b>ER110CJ31130</b>	B3113-372-000	Morsetto
	7	<b>ER110CJ14022</b>	B1402-372-000	Boccola sup.
	1	<b>ER110CJ01372</b>	B1401-372-000A	<b>Barra ago</b>
	8	<b>ER110CJ14210</b>	B1421-372-000	Protezione barra ago

	Pos	Codice	Originale	Descrizione
		<b>ER110CJ1037A</b>	B1210-372-0A0	<b>Camme completa</b>
	1	<b>ER110CJN615P</b>	NS-6150430-SP	Dado
	2	<b>ER110CJ12113</b>	B1211-372-000	Dente di fermo
	3	<b>ER110CJ12122</b>	B1212-372-00B	Scatto di fermo
	4	<b>ER110CJ12132</b>	B1213-372-000	Vite
	5	<b>ER110CJS871T</b>	SS-8701782-TP	Vite
6	<b>ER110CJS870T</b>	SS-8701042-TP	Vite	

 <b>ER110CJ26152</b> B2615-372-000 Vite	 <b>ER110CJ26162</b> B2616-372-000 Molla	 <b>ER110CJ26052</b> B2605-372-000 Albero	 <b>ER110CJ26042</b> B264-372-000 Blocchetto	 <b>ER110CJW76SD</b> WP-0751576-SD TV <b>ER110CJ82200</b> B8220-804-000 TN	 <b>ER110CJN668S</b> NS-6680410-SP Dado
---	--	--	---	---	---

 <b>ER110CJ26602</b> B2606-372-000 Rondella	 <b>ER110CJ26072</b> B2607-372-000 TV <b>ER110CJ26080</b> B2608-280-000 TN	 <b>ER110CJ26382</b> B2638-372-000 Vite	 <b>ER110CJ26242</b> B2624-372-000 Vite	 <b>ER110CJ26082</b> B2608-372-000 Perno
---	---	---	---	--

**Cl. MBH-180, MEB-1890**

	Codice	Originale	Misura			
	<b>ER106C258014</b>	B2701-180-F00	6,35-1/4"			
	<b>ER106C258038</b>	B2701-180-K00	9,53-3/8"			
	<b>ER106C258012</b>	B2701-180-L00	12,7-1/2"			
	<b>ER106C258916</b>	B2701-180-V00	14,29-9/16"			
	<b>ER106C258058</b>	B2701-180-M00	15,88-5/8"			
	<b>ER106C258034</b>	B2701-180-N00	19,05-3/4"			
	<b>ER106C258078</b>	B2701-180-P00	22,23-7/8"			
	<b>ER106C258001</b>	B2701-180-Q00	25,4-1"			
	<b>ER106C258118</b>	B2701-180-R00	28,57-1,1/8"			
<b>ER106C258114</b>	B2701-180-S00	31,75-1,1/4"	<b>ER104C000601</b>	<b>10C000602</b>	<b>ER110CJ09180</b>	
<b>ER106C258138</b>	B2701-180-T00	34,9-1,3/8"	B2523-180-000	B2524-180-000	B1109-180-000	

**Cl. MF-850, 860, 880, 890, 2600 MFB-860, 2600**



**ER106CJ11012**  
MAS-11012-000



**ER106CJ11013**  
MAS-11013-000



**ER106CJ11016**  
MAS-11016-000



**ER106CJ11017**  
MAS-11017-000



**ER104CJ25148**  
B2514-860-000



**ER104CJ2514G**  
B2514-860-G00



**ER104CJ2514A**  
B2514-860-A00

**Cl. MH-38**



**ER104C000603**  
B2008-038-F00



**ER104C000604**  
B2009-038-F00

**Cl. MS-19**



**ER104CJ3019F**  
B2513-019-F00



**ER104CJ3019D**  
B2513-019-D00



**ER104CJ4019F**  
B2514-019-F00



**ER104CJ4019D**  
B2514-019-D00



**ER110CJ8019D**  
B1108-019-D0A.3/16"  
**ER110CJ8019F**  
B1108-019-F0A.1/4"

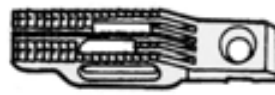

**ER110CJ4019D**  
B1604-019-D0A.3/16"  
**ER110CJ8019F**  
B1604-019-F00.1/4"



**ER110CJ7019D**  
B1507-019-DA0.3/16"  
**ER110CJ7019F**  
B1507-019-FA0.1/4"

**Cl. MS-26**



**ER104C000600**  
B2513-026-F00





**ER104C000599**  
B2514-026-000

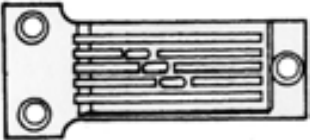

**ER104C000598**  
B2515-026-F00

Cl. MS-26 (segue)

 <b>ER110CJ8026F</b> B1108-026-F00.1/4"	 <b>ER110CJ4026F</b> B1604-026-F00.1/4"	 <b>ER110CJ7026F</b> B1507-026-FA0.1/4"
--	--	--

DADI (NON ILLUSTRATI)		VITI SD (NON ILLUSTRATI)		VITI (NON ILLUSTRATI)	
Codice	Originale	Codice	Originale	Codice	Originale
<b>ER110CJN608P</b>	NS-6080210-SP	<b>ER110CJSD46T</b>	SD-0460702-TP	<b>ER110CJSL03S</b>	SL-4030621-SS
<b>ER110CJN609N</b>	NS-6090530-SP	<b>ER110CJSD60T</b>	SD-0600341-TP		
<b>ER110CJN612P</b>	NS-6120310-SP	<b>ER110CJSD63S</b>	SD-0630275-SP	<b>ER110CJSM05P</b>	SM-6051202-TP
<b>ER110CJN614S</b>	NS-6150440-SP	<b>ER110CJSD64S</b>	SD-0640241-SP	<b>ER110CJSM85R</b>	SM-9061853-SR
<b>ER110CJN662P</b>	NS-6620310-SP	<b>ER110CJSD72T</b>	SD-0720801-TH		
<b>ER110CJN664P</b>	NS-6660430-SP				
<b>ER110CJN660P</b>	NS-6680480-SP				