







## PARTI PER BROTHER

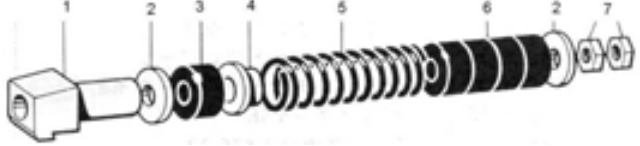
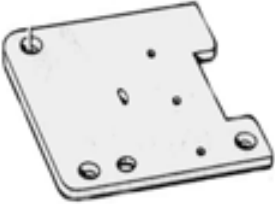

Cl. CB3-B915, B916, B917

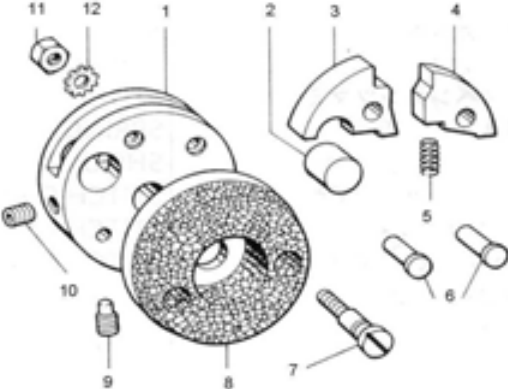
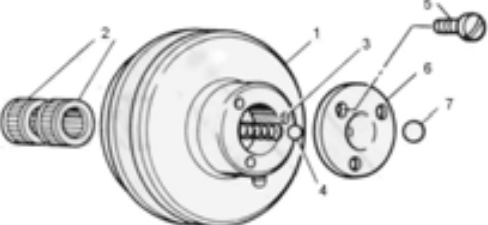
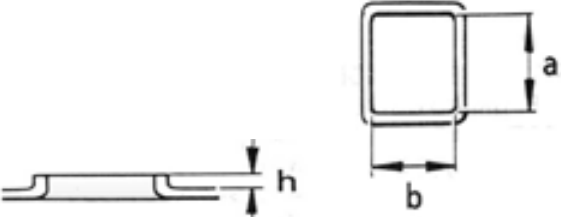

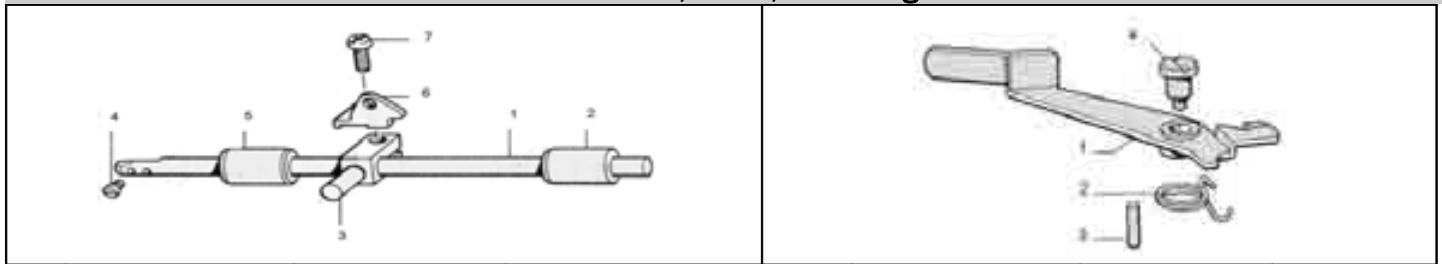

 <b>ER110CB03429</b> S03429-101 <b>ER110CB62710</b> 062710-612 Vite	 <b>ER110CB03394</b> S03394-001																																																							
 <b>ER110CB03430</b> S03430-001 Cl. 912, 913 <b>ER110CB36622</b> S36622-001 Cl. 916, 917 <b>ER110CB01702</b> S01702-001 Vite	<table border="1"> <thead> <tr> <th>Pos.</th> <th>Codice</th> <th>Originale</th> <th>Descrizione</th> </tr> </thead> <tbody> <tr> <td>1</td> <td><b>ER110CB03393</b></td> <td>S03393-001</td> <td>Fermo</td> </tr> <tr> <td>2</td> <td><b>ER110CB25800</b></td> <td>O25800-332</td> <td>Anello</td> </tr> <tr> <td>3</td> <td><b>ER110CB03395</b></td> <td>S03395-000</td> <td>Gommino</td> </tr> <tr> <td>4</td> <td><b>ER110CB34806</b></td> <td>S34806-001</td> <td>Porta molla</td> </tr> <tr> <td>5</td> <td><b>ER110CB36693</b></td> <td>S36693-001</td> <td>Molla</td> </tr> <tr> <td>6</td> <td><b>ER110CB15018</b></td> <td>115018-001</td> <td>Gommini</td> </tr> <tr> <td>7</td> <td><b>ER110CB21800</b></td> <td>O21800-102</td> <td>Dado</td> </tr> </tbody> </table>				Pos.	Codice	Originale	Descrizione	1	<b>ER110CB03393</b>	S03393-001	Fermo	2	<b>ER110CB25800</b>	O25800-332	Anello	3	<b>ER110CB03395</b>	S03395-000	Gommino	4	<b>ER110CB34806</b>	S34806-001	Porta molla	5	<b>ER110CB36693</b>	S36693-001	Molla	6	<b>ER110CB15018</b>	115018-001	Gommini	7	<b>ER110CB21800</b>	O21800-102	Dado																				
Pos.	Codice	Originale	Descrizione																																																					
1	<b>ER110CB03393</b>	S03393-001	Fermo																																																					
2	<b>ER110CB25800</b>	O25800-332	Anello																																																					
3	<b>ER110CB03395</b>	S03395-000	Gommino																																																					
4	<b>ER110CB34806</b>	S34806-001	Porta molla																																																					
5	<b>ER110CB36693</b>	S36693-001	Molla																																																					
6	<b>ER110CB15018</b>	115018-001	Gommini																																																					
7	<b>ER110CB21800</b>	O21800-102	Dado																																																					
	<table border="1"> <thead> <tr> <th>Pos.</th> <th>Codice</th> <th>Originale</th> <th>Descrizione</th> </tr> </thead> <tbody> <tr> <td>1</td> <td><b>ER110CB03392</b></td> <td>S03392-001</td> <td>Leva</td> </tr> <tr> <td>2</td> <td><b>ER110CB15012</b></td> <td>115012-002</td> <td>Vite</td> </tr> <tr> <td>3</td> <td><b>ER110CB50554</b></td> <td>150554-002</td> <td>Dado</td> </tr> <tr> <td>4</td> <td><b>ER110CB15011</b></td> <td>115011-201</td> <td>Vite</td> </tr> </tbody> </table>				Pos.	Codice	Originale	Descrizione	1	<b>ER110CB03392</b>	S03392-001	Leva	2	<b>ER110CB15012</b>	115012-002	Vite	3	<b>ER110CB50554</b>	150554-002	Dado	4	<b>ER110CB15011</b>	115011-201	Vite																																
Pos.	Codice	Originale	Descrizione																																																					
1	<b>ER110CB03392</b>	S03392-001	Leva																																																					
2	<b>ER110CB15012</b>	115012-002	Vite																																																					
3	<b>ER110CB50554</b>	150554-002	Dado																																																					
4	<b>ER110CB15011</b>	115011-201	Vite																																																					
	<table border="1"> <thead> <tr> <th>Pos.</th> <th>Codice</th> <th>Originale</th> <th>Descrizione</th> </tr> </thead> <tbody> <tr> <td>1</td> <td><b>ER110CB03382</b></td> <td>S03382-101</td> <td>Camme</td> </tr> <tr> <td>2</td> <td><b>ER110CB03385</b></td> <td>S03385-000</td> <td>Gommino</td> </tr> <tr> <td>3</td> <td><b>ER110CB03384</b></td> <td>S03384-001</td> <td>Settore di stop</td> </tr> <tr> <td>4</td> <td><b>ER110CB03383</b></td> <td>S03383-001</td> <td>Settore di fermo</td> </tr> <tr> <td>5</td> <td><b>ER110CB03386</b></td> <td>S03386-001</td> <td>Molla</td> </tr> <tr> <td>6</td> <td><b>ER110CB15004</b></td> <td>115004-001</td> <td>Rulli</td> </tr> <tr> <td>7</td> <td><b>ER110CB05725</b></td> <td>S05725-001</td> <td>Vite</td> </tr> <tr> <td>8</td> <td><b>ER110CB03387</b></td> <td>S03387-001</td> <td>Frizione</td> </tr> <tr> <td>9</td> <td><b>ER110CB49996</b></td> <td>149996-001</td> <td>Vite</td> </tr> <tr> <td>10</td> <td><b>ER110CB14821</b></td> <td>O14821-022</td> <td>Vite</td> </tr> <tr> <td>11</td> <td><b>ER110CB21750</b></td> <td>O21750-112</td> <td>Dado</td> </tr> <tr> <td>12</td> <td><b>ER110CB15000</b></td> <td>115000-000</td> <td>Seiger</td> </tr> </tbody> </table>				Pos.	Codice	Originale	Descrizione	1	<b>ER110CB03382</b>	S03382-101	Camme	2	<b>ER110CB03385</b>	S03385-000	Gommino	3	<b>ER110CB03384</b>	S03384-001	Settore di stop	4	<b>ER110CB03383</b>	S03383-001	Settore di fermo	5	<b>ER110CB03386</b>	S03386-001	Molla	6	<b>ER110CB15004</b>	115004-001	Rulli	7	<b>ER110CB05725</b>	S05725-001	Vite	8	<b>ER110CB03387</b>	S03387-001	Frizione	9	<b>ER110CB49996</b>	149996-001	Vite	10	<b>ER110CB14821</b>	O14821-022	Vite	11	<b>ER110CB21750</b>	O21750-112	Dado	12	<b>ER110CB15000</b>	115000-000	Seiger
Pos.	Codice	Originale	Descrizione																																																					
1	<b>ER110CB03382</b>	S03382-101	Camme																																																					
2	<b>ER110CB03385</b>	S03385-000	Gommino																																																					
3	<b>ER110CB03384</b>	S03384-001	Settore di stop																																																					
4	<b>ER110CB03383</b>	S03383-001	Settore di fermo																																																					
5	<b>ER110CB03386</b>	S03386-001	Molla																																																					
6	<b>ER110CB15004</b>	115004-001	Rulli																																																					
7	<b>ER110CB05725</b>	S05725-001	Vite																																																					
8	<b>ER110CB03387</b>	S03387-001	Frizione																																																					
9	<b>ER110CB49996</b>	149996-001	Vite																																																					
10	<b>ER110CB14821</b>	O14821-022	Vite																																																					
11	<b>ER110CB21750</b>	O21750-112	Dado																																																					
12	<b>ER110CB15000</b>	115000-000	Seiger																																																					
	<table border="1"> <thead> <tr> <th>Pos.</th> <th>Codice</th> <th>Originale</th> <th>Descrizione</th> </tr> </thead> <tbody> <tr> <td>1</td> <td><b>ER110CB34341</b></td> <td>S34341-001</td> <td>Puleggia</td> </tr> <tr> <td>2</td> <td><b>ER110CB14992</b></td> <td>114992-000</td> <td>Gabbia</td> </tr> <tr> <td>3</td> <td><b>ER110CB14997</b></td> <td>114997-001</td> <td>Molla</td> </tr> <tr> <td>4</td> <td><b>ER110CB71055</b></td> <td>O71055-650</td> <td>Sfera</td> </tr> <tr> <td>5</td> <td><b>ER110CB12751</b></td> <td>112751-003</td> <td>Vite</td> </tr> <tr> <td>6</td> <td><b>ER110CB34340</b></td> <td>S34340-001</td> <td>Fermo sfera</td> </tr> <tr> <td>7</td> <td><b>ER110CB71079</b></td> <td>O71079-450</td> <td>Sfera</td> </tr> </tbody> </table>				Pos.	Codice	Originale	Descrizione	1	<b>ER110CB34341</b>	S34341-001	Puleggia	2	<b>ER110CB14992</b>	114992-000	Gabbia	3	<b>ER110CB14997</b>	114997-001	Molla	4	<b>ER110CB71055</b>	O71055-650	Sfera	5	<b>ER110CB12751</b>	112751-003	Vite	6	<b>ER110CB34340</b>	S34340-001	Fermo sfera	7	<b>ER110CB71079</b>	O71079-450	Sfera																				
Pos.	Codice	Originale	Descrizione																																																					
1	<b>ER110CB34341</b>	S34341-001	Puleggia																																																					
2	<b>ER110CB14992</b>	114992-000	Gabbia																																																					
3	<b>ER110CB14997</b>	114997-001	Molla																																																					
4	<b>ER110CB71055</b>	O71055-650	Sfera																																																					
5	<b>ER110CB12751</b>	112751-003	Vite																																																					
6	<b>ER110CB34340</b>	S34340-001	Fermo sfera																																																					
7	<b>ER110CB71079</b>	O71079-450	Sfera																																																					
		 <b>ER110CB03489</b> S03489-101																																																						
<table border="1"> <thead> <tr> <th>N.</th> <th>Codice</th> <th>Originale</th> <th>Descrizione</th> </tr> </thead> <tbody> <tr> <td>1</td> <td><b>ER110CB03476</b></td> <td>S03476-101</td> <td>Placca trasporto A 4,8x4,8x1</td> </tr> <tr> <td>2</td> <td><b>ER110CB03630</b></td> <td>S03630-101</td> <td>Placca trasporto B 4,8x4,8x0</td> </tr> <tr> <td>3</td> <td><b>ER110CB15085</b></td> <td>115085-001</td> <td>Placca trasporto C 7 x 7 x0</td> </tr> <tr> <td>4</td> <td><b>ER110CB03632</b></td> <td>S03632-101</td> <td>Placca trasporto D 7 x 7 x1</td> </tr> </tbody> </table>	N.	Codice	Originale	Descrizione	1	<b>ER110CB03476</b>	S03476-101	Placca trasporto A 4,8x4,8x1	2	<b>ER110CB03630</b>	S03630-101	Placca trasporto B 4,8x4,8x0	3	<b>ER110CB15085</b>	115085-001	Placca trasporto C 7 x 7 x0	4	<b>ER110CB03632</b>	S03632-101	Placca trasporto D 7 x 7 x1																																				
N.	Codice	Originale	Descrizione																																																					
1	<b>ER110CB03476</b>	S03476-101	Placca trasporto A 4,8x4,8x1																																																					
2	<b>ER110CB03630</b>	S03630-101	Placca trasporto B 4,8x4,8x0																																																					
3	<b>ER110CB15085</b>	115085-001	Placca trasporto C 7 x 7 x0																																																					
4	<b>ER110CB03632</b>	S03632-101	Placca trasporto D 7 x 7 x1																																																					

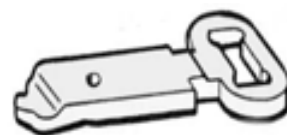



Cl. CB3-B915, B916, B917 segue





N.	Codice	Originale	Descrizione	N.	Codice	Originale	Descrizione
1	<b>ER110CB03423</b>	S03423-001	Barra ago	1	<b>ER110CB03552</b>	S03552-001	Leva
2	<b>ER110CB03424</b>	S03424-000	Boccola	2	<b>ER110CB03554</b>	S03554-001	Molla
3	<b>ER110CB03427</b>	S03427-101	Morsetto	3	<b>ER110CB03555</b>	S03555-001	Perno
4	<b>ER110CB40553</b>	140553-102	Vite ago	4	<b>ER110CB03553</b>	S03553-001	Vite
5	<b>ER110CB03425</b>	S03425-000	Boccola				
6	<b>ER110CB03428</b>	S03428-001	Prendi filo				
7	<b>ER110CB62671</b>	062671-212	Vite				

 <p>ER104CB15069 115069-001 Cl. B913, B915 <b>ER104CB03536</b> S03536-001 Cl. B916, B917</p>	 <p>ER110CB03569 S03569-001 Cl. B913, B915 <b>ER110CB36625</b> S36625-001 Cl. B916, B917</p>	 <p><b>ER110CB15073</b> 115073-001 Leva <b>ER110CB15077</b> 115077-001 Vite <b>ER110CB15076</b> 115076-001 Rullino</p>
--	---	---

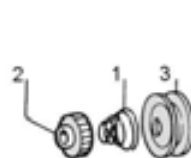
 <p><b>ER110CB51972</b> 151972-001 Coltello mobile Cl. B913, B915</p>	 <p><b>ER110CB51979</b> 151979-001 Coltello fisso Cl. B913, B915</p>	 <p><b>ER110CB03627</b> S03627-001 Coltello mobile Cl. B916, B917</p>	 <p><b>ER110CB03629</b> S03629-001 Coltello fisso Cl. B916, B917</p>
---	--	--	--

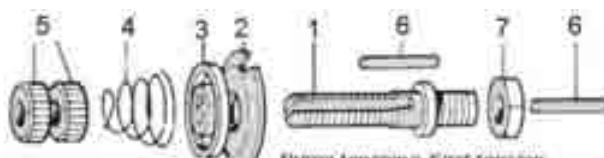

 <p><b>ER110CB15183</b> 115183-101 <b>ER110CB62710</b> 062710-612 Vite</p>	 <p><b>ER110CB03560</b> S03560-001 <b>ER110CB13710</b> 013710-712 Vite</p>	 <p><b>ER110CB03565</b> S03565-001 <b>ER110CB62711</b> 062711-012 Vite</p>	 <p><b>ER110CB03564</b> S03564-001 <b>ER110CB62711</b> 062711-012 Vite</p>	 <p>1) <b>ER110CB44505</b> 144505-000 Molla 2) <b>ER110CB55510</b> 155510-001 Pomello 3) <b>ER110CB44504</b> 144504-001 Piattello</p>
--	---	---	---	--

 <p>Primo tensione First tension</p>	<table border="1"> <thead> <tr> <th>Pos.</th> <th>Codice</th> <th>Originale</th> <th>Descrizione</th> </tr> </thead> <tbody> <tr> <td>1</td> <td><b>ER110CB03550</b></td> <td>S03550-001</td> <td>Perno</td> </tr> <tr> <td>2</td> <td><b>ER110CB15187</b></td> <td>115187-101</td> <td>Piattello</td> </tr> <tr> <td>3</td> <td><b>ER110CB59805</b></td> <td>159805-001</td> <td>Disco pressione</td> </tr> <tr> <td>4</td> <td><b>ER110CB06432</b></td> <td>S06432-001</td> <td>Molla</td> </tr> <tr> <td>5</td> <td><b>ER110CB00136</b></td> <td>100136-001</td> <td>Pomello</td> </tr> <tr> <td>6</td> <td><b>ER110CB03551</b></td> <td>S03551-001</td> <td>Perno</td> </tr> <tr> <td>7</td> <td><b>ER110CB50556</b></td> <td>150556-001</td> <td>Dado</td> </tr> </tbody> </table>	Pos.	Codice	Originale	Descrizione	1	<b>ER110CB03550</b>	S03550-001	Perno	2	<b>ER110CB15187</b>	115187-101	Piattello	3	<b>ER110CB59805</b>	159805-001	Disco pressione	4	<b>ER110CB06432</b>	S06432-001	Molla	5	<b>ER110CB00136</b>	100136-001	Pomello	6	<b>ER110CB03551</b>	S03551-001	Perno	7	<b>ER110CB50556</b>	150556-001	Dado
Pos.	Codice	Originale	Descrizione																														
1	<b>ER110CB03550</b>	S03550-001	Perno																														
2	<b>ER110CB15187</b>	115187-101	Piattello																														
3	<b>ER110CB59805</b>	159805-001	Disco pressione																														
4	<b>ER110CB06432</b>	S06432-001	Molla																														
5	<b>ER110CB00136</b>	100136-001	Pomello																														
6	<b>ER110CB03551</b>	S03551-001	Perno																														
7	<b>ER110CB50556</b>	150556-001	Dado																														

 <p>Seconda tensione Second tension</p>	<table border="1"> <thead> <tr> <th>Pos.</th> <th>Codice</th> <th>Originale</th> <th>Descrizione</th> </tr> </thead> <tbody> <tr> <td>1</td> <td><b>ER110CB03545</b></td> <td>S03545-001</td> <td>Perno</td> </tr> <tr> <td>2</td> <td><b>ER110CB15187</b></td> <td>115187-101</td> <td>Piattello</td> </tr> <tr> <td>3</td> <td><b>ER110CB59805</b></td> <td>159805-001</td> <td>Disco pressione</td> </tr> <tr> <td>4</td> <td><b>ER110CB48924</b></td> <td>148924-101</td> <td>Molla Tension</td> </tr> <tr> <td>5</td> <td><b>ER110CB00136</b></td> <td>100136-001</td> <td>Pomello</td> </tr> <tr> <td>6</td> <td><b>ER110CB03546</b></td> <td>S03546-001</td> <td>Perno</td> </tr> </tbody> </table>	Pos.	Codice	Originale	Descrizione	1	<b>ER110CB03545</b>	S03545-001	Perno	2	<b>ER110CB15187</b>	115187-101	Piattello	3	<b>ER110CB59805</b>	159805-001	Disco pressione	4	<b>ER110CB48924</b>	148924-101	Molla Tension	5	<b>ER110CB00136</b>	100136-001	Pomello	6	<b>ER110CB03546</b>	S03546-001	Perno
Pos.	Codice	Originale	Descrizione																										
1	<b>ER110CB03545</b>	S03545-001	Perno																										
2	<b>ER110CB15187</b>	115187-101	Piattello																										
3	<b>ER110CB59805</b>	159805-001	Disco pressione																										
4	<b>ER110CB48924</b>	148924-101	Molla Tension																										
5	<b>ER110CB00136</b>	100136-001	Pomello																										
6	<b>ER110CB03546</b>	S03546-001	Perno																										

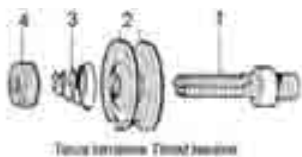
CI. CB3-B915, B916, B917 segue

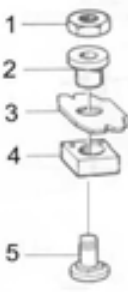
	Pos.	Codice	Originale	Descrizione
	1	<b>ER110CB15186</b>	115186-001	Perno
	2	<b>ER110CB15187</b>	115187-101	Piattello
	3	<b>ER110CB15188</b>	115188-002	Molla
	4	<b>ER110CB00136</b>	100136-001	Pomello

	N.	Codice	Originale	Descrizione	 <p><b>ER110CB09488</b> S09488-001</p>
	1	<b>ER110CB50556</b>	150556-001	Dado	
	2	<b>ER110CB31723</b>	S31723-001	Bussola	
	3	<b>ER110CB03480</b>	S03480-001	Guida	
	4	<b>ER110CB03478</b>	S03478-001	Blocchetto	
	5	<b>ER110CB31724</b>	S31724-001	Vite	

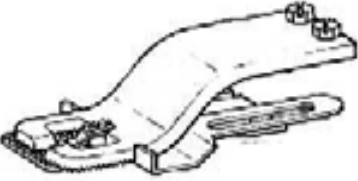
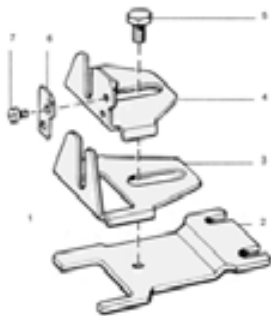
 <p><b>ER110CB3692</b> S03692-001</p>		N.	Codice	Originale	Descrizione
		1	<b>ER110CB50416</b>	150416-001	Pinza cpl.
		2	<b>ER110CB09489</b>	S09489-001	Piastra
		3	<b>ER110CB09490</b>	S09490-001	Guida larga
		4	<b>ER110CB09491</b>	S09491-001	Guida stretta
		5	<b>ER110CB09495</b>	S09495-001	Vite
		6	<b>ER110CB09492</b>	S09492-001	Prendi filo
		7	<b>ER110CB09496</b>	S09496-001	Vite

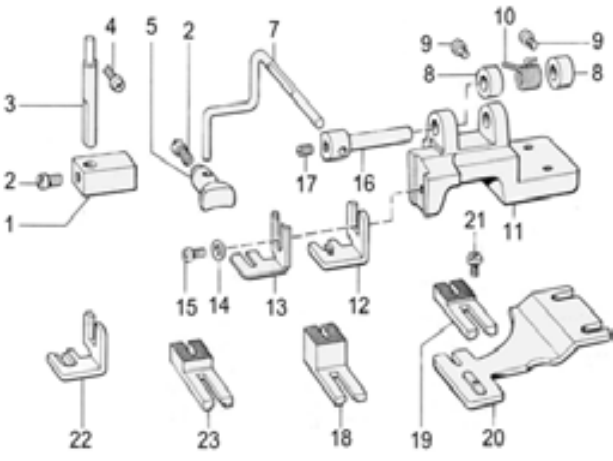
 	N.	Codice	Originale	Descrizione
	1>23	<b>ER110CB42570</b>	142570-009	<b>Pinza Completa 913/5</b>
	1<23	<b>ER110CB07877</b>	S07877-001	<b>Pinza Completa 916/7</b>
	5>15	<b>ER110CB42689</b>	142689-206	Gr. anter. Cpl 916/7
	1	<b>ER110CB42683</b>	142683-101	Blocchetto
	2	<b>ER110CB20990</b>	120990-001	Vite
	3	<b>ER110CB42684</b>	142684-001	Asta
	4	<b>ER110CB62711</b>	062711-012	Vite
	5	<b>ER110CB42680</b>	142680-001	Ferma bott.
	7	<b>ER110CB54686</b>	154686-001	Supporto
	8	<b>ER110CB42706</b>	142706-001	Anello
	9	<b>ER110CB62677</b>	062670-712	Vite
	10	<b>ER110CB54685</b>	154685-001	Molla
	11	<b>ER110CB54684</b>	154684-009	Supporto
	12	<b>ER110CB42678</b>	142678-001	Pinza bott. B
	13	<b>ER110CB42677</b>	142677-001	Pinza bott. A
	14	<b>ER110CB02707</b>	102707-003	Rondella
	15	<b>ER110CB62678</b>	062670-812	Vite
	16	<b>ER110CB42681</b>	142681-001	Perno
	17	<b>ER110CB13719</b>	013719-412	Vite
	18	<b>ER110CB42688</b>	142688-001	Suola alta
	19	<b>ER110CB46686</b>	146686-001	Suola bassa
	20	<b>ER110CB56336</b>	156336-001	Piastra
21	<b>ER110CB60670</b>	060670-512	Vite	
22	<b>ER110CB03641</b>	S03641-001	Pinza bott. D	
23	<b>ER110CB42687</b>	142687-001	Suola media	

CI. CB3-B915, B916, B917 segue

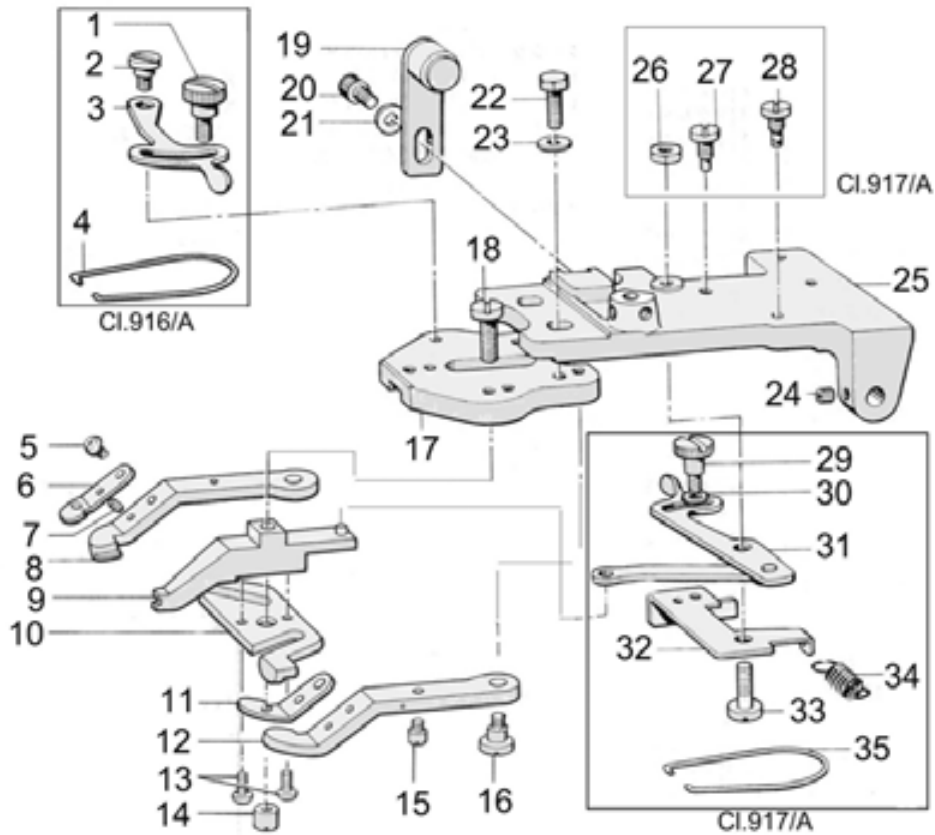

N.	codice	Originale	Descrizione	N.	codice	Originale	Descrizione
1>25	<b>ER110CB15167</b>	115167-001	Pinza CPL A 10>20 913/5	13	<b>ER110CB62688</b>	062680-812	Vite
1>25	<b>ER110CB03457</b>	S03457-001	Pinza CPL A 10>20 916	14	<b>ER110CB03657</b>	S03657-001	Dado
1>25	<b>ER110CB03635</b>	S03635-001	Pinza CPL B 10>30 916	15	<b>ER110CB15156</b>	115156-001	Perno
				16	<b>ER110CB15158</b>	115158-001	Vite
5>35	<b>ER110CB03599</b>	S03599-001	917 Pinza CPL A 10>20	17	<b>ER110CB03464</b>	S03464-101	Supporto
5>35	<b>ER110CB37438</b>	S37438-109	917 Pinza CPL B 10>20	18	<b>ER110CB03468</b>	S03468-001	Vite
5>35	<b>ER110CB37436</b>	S37436-109	917 Pinza CPL C 10>30	19	<b>ER110CB03459</b>	S03459-001	Regolo
				20	<b>ER110CB18061</b>	018061-022	Vite
1	<b>ER110CB15166</b>	115166-001	Vite	21	<b>ER110CB03695</b>	S03695-001	Rondella
2	<b>ER110CB15165</b>	115165-001	Vite	22	<b>ER110CB17711</b>	017711-412	Vite
3	<b>ER110CB15164</b>	115164-001	Leva	23	<b>ER110CB46354</b>	146354-001	Rondella
4	<b>ER110CB15163</b>	115163-001	Molla	24	<b>ER110CB14680</b>	014680-622	Vite
5	<b>ER110CB62680</b>	062680-512	Vite	25	<b>ER110CB37352</b>	S37352-009	Supporto
6	<b>ER110CB30001</b>	S30001-001	Molla sn A	26	<b>ER110CB50556</b>	150556-001	Dado
6	<b>ER110CB11079</b>	S11079-001	Molla sn B	27	<b>ER110CB03606</b>	S03606-001	Vite
7	<b>ER110CB47250</b>	047250-642	Perno	28	<b>ER110CB03608</b>	S03608-001	Vite
8	<b>ER110CB29998</b>	S29998-001	Pinza sn A	29	<b>ER110CB15166</b>	115166-001	Vite
8	<b>ER110CB03650</b>	S03650-001	Pinza sn B	30	<b>ER110CB25680</b>	025680-232	Rondella
9	<b>ER110CB29954</b>	S29954-001	Indice A	31	<b>ER110CB03600</b>	S03600-001	Leva
9	<b>ER110CB03467</b>	S03467-001	Indice B	32	<b>ER110CB03604</b>	S03604-001	Supporto
10	<b>ER110CB03659</b>	S03659-001	Cam	33	<b>ER110CB03605</b>	S03605-001	Vite
11	<b>ER110CB30002</b>	S30002-001	Molla ds A	34	<b>ER110CB03607</b>	S03607-001	Molla
11	<b>ER110CB11080</b>	S11080-001	Molla ds B	35	<b>ER110CB03610</b>	S03610-001	Molla
12	<b>ER110CB29999</b>	S29999-001	Pinza ds A				
12	<b>ER110CB03649</b>	S03649-001	Pinza ds B				

**Cl. CB3-B915, B916, B917 segue**

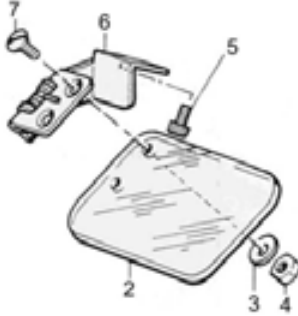
 <p><b>ER110CB43971</b> 143971-001 Protezione Cl. B913, B915</p>	 <p>Protezione Cl. B916, B917</p>	N.	Codice	Originale	Descrizione
		1	<b>ER110CB37137</b>	S37137-001	Protez. cpl.
		2	<b>ER110CB43966</b>	143966-001	Protezione
		3	<b>ER110CB25032</b>	025030-232	Rondella
		4	<b>ER110CB21660</b>	021660-102	Dado
		5	<b>ER110CB18400</b>	018400-632	Vite
		6	<b>ER110CB37132</b>	S37132-001	Cerniera
		7	<b>ER110CB01700</b>	S01700-001	Vite

**DT6-B924**







 <p><b>ER104CB69085</b> SY 006 9085</p>	 <p><b>ER104CB69086</b> SY 006 9086</p>	 <p><b>ER104CB69084</b> SY 006 9084</p>
--	--	--

**DT6-B926**

 <p><b>ER104CB11162</b> 111162-001</p>	 <p><b>ER104CB11160</b> 111160-001</p>	 <p><b>ER104CB11157</b> 111157-001</p>
---	---	---

**DT6-B926-6A, B928A**

 <p><b>ER104CB48869</b> 148869-001 <b>ER110CB48872</b> 148872-001 Porta crochet</p>	 <p><b>ER104CB48870</b> 148870-001 <b>ER110CB48873</b> 148873-001 Porta crochet</p>	 <p><b>ER104CB48871</b> 148871-001 <b>ER110CB48874</b> 148874-001 Porta crochet</p>
--	--	--

 <p><b>ER110CB81716</b> 181716-001 Mors. <b>ER110CB46427</b> 146427-001 Vite A</p>	 <p><b>ER110CB50672</b> 150672-001 Piedino</p>	 <p><b>ER110CB48864</b> 148864-001 Placca ago</p>	 <p><b>ER110CB48867</b> 148867-001 Griffa</p>	 <p><b>ER110CB48876</b> 148876-001 Supporto salva ago</p>	 <p><b>ER110CB48875</b> 148875-001 Salva ago</p>
---	---	--	---	--	---

CI. B931

CI.LS5-P73/P81



ER104C000620  
110121-001





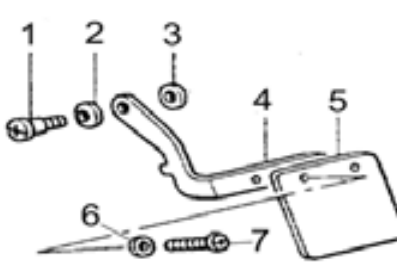

ER106C000210  
S 27634-001

CI. EF4-N11/N21/N31 (V41/V51/V61)

	Pos.	Codice	Originale	Descrizione
	1	ER110CB20342	S20342-001	Vite
	2	ER110CB46598	146598-001	Rondella
	3	ER110CB25050	025050-132	Rondella
	4	ER110CB20340	S20340-001	Supporto
	5	ER110CB00075	S00075-000	Vetrino protezione
	6	ER110CB25350	025350-332	Dado
	7	ER110CB60350	060350-812	Vite





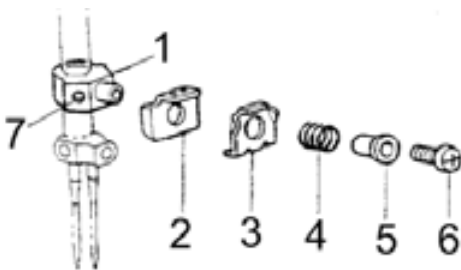

 <b>ER110CB39653</b> S39653-051 <b>ER110CB62350</b> 062350-612 Vite	 <b>ER110CB20416</b> S20416-101 <b>ER110CB20417</b> S20417-101 Vite	 <b>ER110CB38306</b> S38306-051 N31 <b>ER110CB62350</b> 062350-612 Vite	 <b>ER110CB38307</b> S38307-051 N31 <b>ER110CB62308</b> 062300-812 Vite	 <b>ER110CB20418</b> S20418-001 N31 <b>ER110CB23456</b> S23456-101 Vite
--	---	--	--	---

 <b>ER110CB38308</b> S38308-021 Asta piedino	 <b>ER106CB20118</b> S20118-001 <b>ER110CB62300</b> 060300-512 Vite	 <b>ER110CB39659</b> S39659-021 Leva alza piedino	 <b>ER110CB02606</b> S02606-001 Tappo olio	 <b>ER110CB44124</b> 144124-001 Chiave ago
--	--	---	--	--

	Pos.	Codice	Originale	Descrizione
	1	ER110CB38338	S38338-001	Supporto N21
	1	ER110CB38330	S38330-050	Supporto N31
	2	ER110CB20692	S20692-001	Passafilo
	3	ER110CB20691	S20691-001	Piastrina N21
	3	ER110CB20743	S20743-001	Piastrina N31
	4	ER110CB20690	S20690-001	Molla
	5	ER110CB20689	S20689-001	Tubetto
6	ER110CB60300	060300-512	Vite	
7	ER110CB46427	146427-001	Vite	

**CI. EF4-N11/N21/N31 (V41/V51/V61) segue**

				
<b>ER110CB21128</b> S21128-001 4 Fili <b>ER110CB21125</b> S21125-001 3 5 Fili	<b>ER110CB21129</b> S21129-001 4 Fili <b>ER110CB21126</b> S21126-001 3 5 Fili	<b>ER110CB21127</b> S21127-001 3 Fili <b>ER110CB38329</b> S38329-001 5 Fili	<b>ER110CB21130</b> S21130-001	<b>ER110CB21133</b> S21133-001 1 <b>ER110CB21134</b> S21134-001 2

					
<b>ER110CB20685</b> S20685-001	<b>ER110CB21137</b> S21137-001	<b>ER110CB21136</b> S21136-101	<b>ER110CB20686</b> S20686-001	<b>ER110CB20687</b> S20687-001	<b>ER110CB21135</b> S21135-001



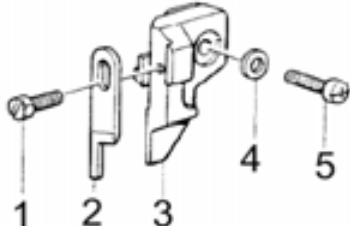

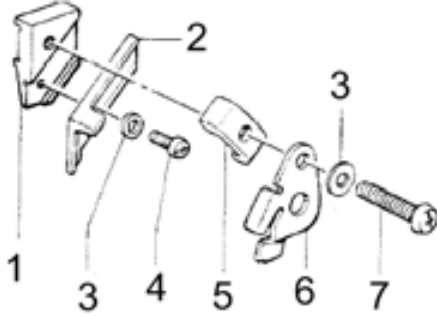



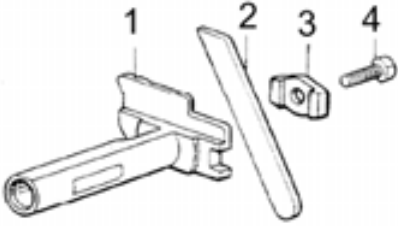











	Pos	Codice	Originale	Descrizione	Colore
	1	<b>ER110CB2068B</b>	S20682-101	Pomello	Blu - Ago SN
	1	<b>ER110CB2068R</b>	S20682-103	Pomello	Rosso - Ago DS
	1	<b>ER110CB2068V</b>	S20682-102	Pomello	Verde - Crochet Sup.
	1	<b>ER110CB2068G</b>	S20682-104	Pomello	Giallo - Crochet Inf.
	2	<b>ER110CB20681</b>	S20681-001	Ghiera	
	3	<b>ER110CB20678</b>	S20678-001	Molla	Aghi
	3	<b>ER110CB20679</b>	S20679-001	Molla	Crochet
	4	<b>ER110CB44103</b>	144103-001	Spingi molla	
	5	<b>ER110CB10832</b>	110832-009	Feltro	
	6	<b>ER110CB20673</b>	S20673-001	Piattello	
	7	<b>ER110CB20677</b>	S20677-001	Feltro	
	8	<b>ER110CB20676</b>	S20676-001	Perno tensione	

	Pos.	Codice	Originale	Descrizione
	1	<b>ER110CB23621</b>	S23621-111	Vite
	2	<b>ER106CB44074</b>	<b>144074-300</b>	<b>Coltello</b>
	3	<b>ER110CB20675</b>	S20575-001	Porta coltello <b>3 4 Fili</b>
	3	<b>ER110CB20589</b>	S20589-001	Porta coltello <b>5 Fili</b>
	4	<b>ER110CB25040</b>	025040-132	Rondella
	5	<b>ER110CB62401</b>	062401-212	Vite

	Pos.	Codice	Originale	Descrizione	
	1	<b>ER110CB20576</b>	S20576-001	Porta coltello <b>3 4 Fili</b>	
	1	<b>ER110CB20590</b>	S20590-001	Porta coltello <b>5 Fili</b>	
	2	<b>ER106CB20896</b>	<b>S20896-001</b>	<b>Coltello Normale 7,8 mm</b>	
	2	<b>ER106CB20759</b>	<b>S20759-001</b>	<b>Coltello CT Widia 7,8 mm</b>	
	2	<b>ER106CB20897</b>	<b>S20897-001</b>	<b>Coltello CT Widia c/denti 7,8 mm</b>	
			<b>ER106CB20898</b>	<b>S20898-001</b>	<b>Coltello CT Widia c/denti 10 mm</b>
	3	<b>ER110CB25030</b>	025030-132	Rondella	
	4	<b>ER110CB62304</b>	062300-412	Vite	
	5	<b>ER110CB20577</b>	S20577-001	Ferma coltello	
	6	<b>ER110CB20578</b>	S20578-101	Copri coltello	
	7	<b>ER110CB62406</b>	062401-612	Vite	



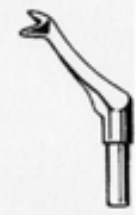
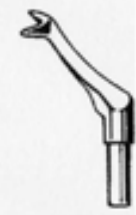







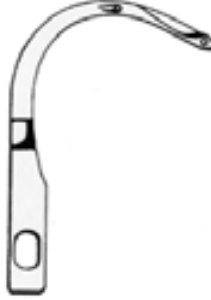

CI. EF4-N11/N21/N31 (V41/V51/V61) segue

	Pos.	Codice	Originale	Descrizione
	1	ER110CB39706	S39706-001	Porta coltello 3 4 Fili
1	ER110CB20591	S20591-001	Porta coltello 5 Fili	
2	ER106CB20582	S20582-001	Coltello 7,8 mm Sp. 1,5	
2	ER106CB20899	S20899-001	Coltello 7,8 mm Sp. 1,0	
2	ER106CB20583	S20583-001	Coltello 10 mm Sp.1,5	
3	ER110CB39708	S39708-001	Ferma coltello	
4	ER110CB17500	017500-812	Vite	









 <b>ER106CB44074</b> 144074-300	 <b>ER106CB20582</b> S20582-001	 <b>ER106CB20896</b> S20896-001	 <b>ER106CB20759</b> S20759-001	 <b>ER106CB20897</b> S20897-001	 <b>ER106CB20899</b> S20899-001
 <b>ER106CB20898</b> S20898-001	 <b>ER106CB20583</b> S20583-001	 <b>ER104CB20422</b> S20422-001 A	 <b>ER104CB20424</b> S20424-001 B	 <b>ER104CB20428</b> S20428-001 C	 <b>ER104CB20430</b> S20430-001 D
 <b>ER104CB20434</b> S20434-001 E	 <b>ER104CB20436</b> S20436-001 F	 <b>ER104CB20438</b> S20438-001 G	 <b>ER104CB20432</b> S20432-001 J	 <b>ER104CB20426</b> S20426-001 H	 <b>ER104CB20440</b> S20440-001 K
 <b>ER104CB20421</b> S20421-001 L	 <b>ER104CB20423</b> S20423-001 M	 <b>ER104CB20429</b> S20429-001 Q	 <b>ER104CB20442</b> S20442-001 R	 <b>ER110CB12400</b> 012400-432 Vite	



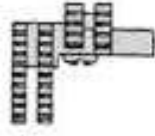

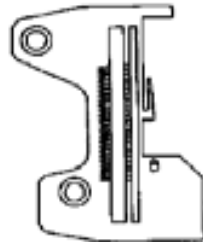

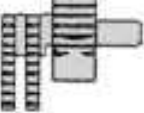

**CI. EF4-N11/N21/N31 (V41/V51/V61) segue**

					
ER104CB20626 S20626-001 N41 31	ER104CB20627 S20627-001 N21	ER104CB40866 S40866-001 N21H	ER110CB60351 060351-012 Vite	ER104CB20653 S20653-001	ER110CB60351 060351-012 Vite
					
ER110CB20393 S20393-001 N41	ER110CB20396 S20396-001 N41 ER110CB46427 146427-001 Vite	ER110CB39572 S39572-001 N11 ER110CB46427 146427-001 Vite	ER110CB39574 S39574-001 N21 31	ER110CB10033 100032-003 Vite placca	ER110CB23621 S23621-101 Vite griffa
					
					ER110CB60630 060630-712 Vite griffino

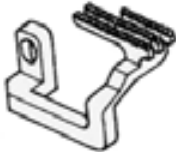
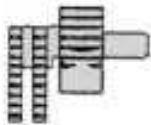



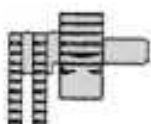



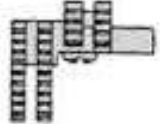

**CI. EF4-N11 (V41) TRASFORMAZIONI**

<b>N11 (V41)</b>					
-01 -3 mm	ER110CB33023 S33023-001	ER110CB33025 S33025-001	ER110CB19199 S19199-001	ER110CB19255 S19255-001	ER110CB19273 S19273-001
-01 -4 mm	ER110CB19145 S19145-001	ER110CB19236 S19236-001		ER110CB19260 S19260-001	
-01 -5 mm	ER110CB19146 S19146-001			ER110CB25535 S25535-001	
-01 -6 mm	ER110CB25165 S25165-001				
<b>N11 (V41)</b>					
-07 -1 mm	ER110CB19153 S19153-001	ER110CB25574 S25574-001	ER110CB19210 S19210-001	ER110CB19271 S19271-001	



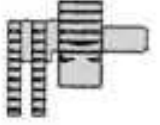

**CI. EF4-N11 (V41) TRASFORMAZIONI segue**

<b>N11 (V41)</b>					
-01 B -3 mm	ER110CB33024 S33024-001	ER110CB33027 S33027-001	ER110CB19212 S19212-001	ER110CB20879 S20879-001	ER110CB19273 S19273-001
-01 B -4 mm	ER110CB19154 S19154-001	ER110CB19240 S19240-001		ER110CB19260 S19260-001	
-01 B -5 mm	ER110CB19155 S19155-001			ER110CB19264 S19264-001	
-01 B -6 mm	ER110CB25161 S25161-001				
<b>N11 (V41)</b>					
-02 B (H) -5 mm	ER110CB19147 S19147-001	ER110CB19237 S19237-001	ER110CB19202 S19202-001	ER110CB19262 S19262-001	ER110CB19273 S19273-001
-02 B (H) -6 mm	ER110CB19148 S19148-001			ER110CB19264 S19264-001	
-02 B (H) -7 mm	ER110CB25186 S25186-001				

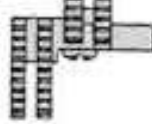

**CI. EF4-N21 (V51) TRASFORMAZIONI**

<b>N21 (V51)</b>	 2,2					
-22 -4 mm	ER110CB20398 S20398-001	ER110CB25190 S15190-001	ER110CB19240 S19240-001	ER110CB19217 S19217-001	ER110CB25543 S25543-001	ER110CB19293 S19293-001
-22 -5 mm		ER110CB19162 S19162-001			ER110CB19280 S19280-001	
-22 -6 mm		ER110CB19163 S19163-001			ER110CB19282 S19282-001	ER110CB25546 S25546-001
-22 -7 mm		ER110CB25191 S25191-001				
<b>N21 (V51)</b>	 2,2					
-22 B -4 mm	ER110CB20398 S20398-001	ER110CB25527 S25527-001	ER110CB19240 S19240-001	ER110CB19212 S19212-001	ER110CB25543 S25543-001	ER110CB19293 S19293-001
-22 B -5 mm		ER110CB19169 S19169-001			ER110CB19280 S19280-001	
-22 B -6 mm		ER110CB19170 S19170-001			ER110CB19282 S19282-001	ER110CB25546 S25546-001
-22 B -7 mm		ER110CB25193 S25193-001				



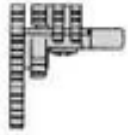
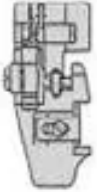

**CI. EF4-N21 (V51) TRASFORMAZIONI segue**

<b>N21 (V51)</b> -24 (H) - 5 mm -24 (H) - 6 mm -24 (H) - 7 mm	 3,0											
							ER110CB19164 S19164-001	ER110CB19242 S19242-001	ER110CB19199 S19199-001	ER110CB19284 S19284-001	ER110CB25546 S25546-001	
							ER110CB20402 S20402-001			ER110CB19165 S19165-001		ER110CB19285 S19285-001
										ER110CB19168 S19168-001		ER110CB29869 S29869-001

**CI. EF4-N31 (V61) TRASFORMAZIONI**

<b>N31 (V61)</b> -63 - 3 mm -63 - 4 mm -63 - 5 mm -63 - 7 mm	 3,0									
						ER110CB20404 S20404-001	ER110CB25190 S15190-001	ER110CB20245 S20245-001	ER110CB20241 S20241-001	ER110CB19313 S19313-201
							ER110CB19162 S19162-001			
							ER110CB19163 S19163-001			
	ER110CB25191 S25191-001									

<b>N31 (V61)</b> -65 - 4 mm -65 - 5 mm -65 - 6 mm -65 - 7 mm	 5,0									
						ER110CB20404 S20404-001	ER110CB25527 S25527-001	ER110CB20244 S20244-001	ER110CB20239 S20239-001	ER110CB19317 S19317-101
							ER110CB19169 S19169-001			
							ER110CB19170 S19170-001			
	ER110CB25193 S25193-001									

**ALTRE VITI PER BROTHER**

 <b>ER110CB09676</b> 009660-612	 <b>ER110CB09670</b> 009670-512	 <b>ER110CB09671</b> 009671-001	 <b>ER110CB18681</b> 018681-022	 <b>ER110CB21670</b> 021670-102 DADO	 <b>ER110CB00105</b> 100105-002
 <b>ER110CB11140</b> 111140-001	 <b>ER110CB11443</b> 111443-001	 <b>ER110CB17517</b> 117517-001	 <b>ER110CB41514</b> 141514-001	 <b>ER110CB43793</b> 143793-001	 <b>ER110CB53221</b> 153221-001
 <b>ER110CB00712</b> S00712-001	 <b>ER110CB00722</b> S00722-001	 <b>ER110CB01295</b> S01295-001	 <b>ER110CB01998</b> S01998-001	 <b>ER110CB10209</b> S10209-101	 <b>ER110CB13399</b> S13399-001
 <b>ER110CB25427</b> S25427-101	 <b>ER110CB49955</b> S49955-101				