

PARTI PER BROTHER

CI. DB2-B715

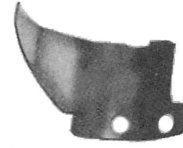

ER110CB11462
111462-001 mm. 7,24



ER106CB45608
145608-001 Coltello mobile

CI. DB2-B716



ER104C000065
153131-901
Normale

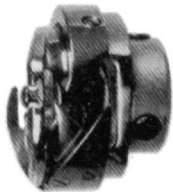

ER104C000123
148846-001
Pesante



ER104C000189
100369-001



ER104C000190
148350-001
Frizionata



ER104C000320
117132-001
Ferro

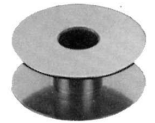

ER104C000343
146290-001
Alluminio

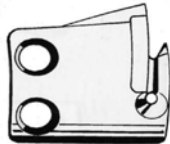

ER106CB54575
154575-001
Coltello mobile

ER110CB48537
148537-001
Vite coltello



ER106CB54568
154568-001
Coltello fisso

ER110CB02843
102843-004
Vite coltello

CI. DB2-B735



ER104C000034
159907-001



ER104C000190
S03245-001



ER104C000320
117132-001



ER110CB00367
100367-001

CI. DB2-B737, B738

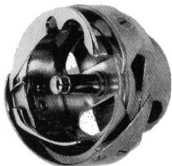

ER104C000066
S02603-901



ER104C000189
100369-001



ER104C000190
148350-001
Frizionata



ER104C000320
117132-001
Ferro

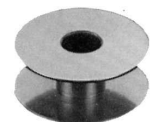

ER104C000343
146290-001
Alluminio



ER110CB02602
S02602-001



ER110CB02681
S02681-101 Scartafilo



ER110CB14144
S14144-000 Gommino filar.



Cl. DB2-B737, B738 segue

		
ER106CB02645 S02645-001 Coltello mobile	ER110CB48537 148537-001 Vite coltello	ER106CB02637 S02637-001 Coltello fisso
	ER110CB02843 102843-004 Vite coltello	ER110CB80018 ER110CB14561 B735/B737/B755/B771/B791
		180018-001 Piastra 114561-001 Molla

Cl. DB2-B755

		
ER104C000062 111275-001 cl. B755-5	ER104C000034 116780-001 cl. B755-3	ER104C000189 100369-001
		ER104C000190 148350-001 Frizionata
		
ER104C000320 117132-001 Ferro	ER104C000343 146290-001 Alluminio	ER110CB00367 100367-001
		ER110CB00327 100327-001 Perno pomello punto

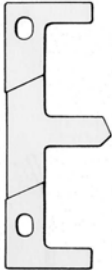



Cl. DBZ-B755

		
ER106CB42061 142061-001 Coltello fisso	ER106CB42058 142058-001 Coltello mobile	ER110CB46094 146094-001 Scartafilo

Cl. DB2-B771/772

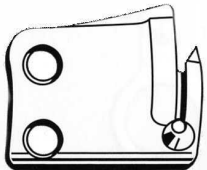
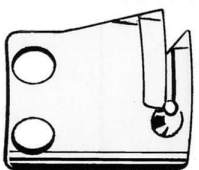
				
ER104C 143784-001 B771	ER104C S13122-001 B771	ER104C000190 S03245-001	ER104C000343 146290-001 Alluminio	ER110CB02602 S02602-001





Cl. DB2-B771/772 segue

				
ER106CB59541 159541-001 Coltello mobile	ER110CB48537 148537-001 Vite coltello	ER106CB59915 159915-001 Coltello mobile S	ER106CB16413 S16413-001 Coltello fisso	ER110CB02843 102843-004 Vite coltello
				
ER106CB10605 S10605-001	ER106CB16371 S16371-001 CT W			













Cl. DB2-B791

				
ER104C 143784-001 Normale	ER104C000123 148846-001 Pesante	ER104C000189 100369-001	ER104C000190 148350-001 Frizionata	ER104C000320 117132-001 Ferro
				
ER110CB00367 100367-001	ER106CB59799 159799-001 Coltello mobile	ER106CB59541 159541-001 Coltello mobile	ER110CB48537 148537-001 Vite coltello	ER106CB59540 159540-001 Coltello fisso
		ER110CB02843 102843-004 Vite coltello		





















Cl. DB2-B735/B77/B755/B771/B791

				
DB2-B735	Barra piedino ER110CB11466 111466-001	Vite piedino ER110CB60671 060671-012	Vite pressione ER110CB41207 141207-001	
DB2-B737	ER110CB11466 111466-001	ER110CB60671 060671-012	ER110CB41207 141207-001	ER110CB47846 147846-001
DB2-B755	ER110CB11466 111466-001	ER110CB01670 001670-814	ER110CB41207 141207-001	ER110CB47846 147846-001
DB2-B771	ER110CB11466 111466-001	ER110CB13386 S13386-001	ER110CB41207 141207-001	
DB2-B791	ER110CB16315 S16315-001	ER110CB13385 S13385-001	ER110CB41207 141207-001	ER110CB47846 147846-001





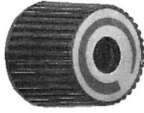

Cl. DB2-B735/B77/B755/B771/B791 segue

						
	Boccola sup.	Boccola inf.	Guidafilo	Barra ago DBx1	Passafilo B/A	Vite ago
DB2-B735	ER110CB11463 111463-001	ER110CB45468 145468-001	ER110CB00573 100573-001	ER110CB02536 S02536-001	ER110CB51594 151594-001	ER110CB40553 140553-102
DB2-B737	ER110CB17242 117242-001	ER110CB45468 145468-001	ER110CB00573 100573-001	ER110CB04628 S04628-001	ER110CB02736 S02736-001	ER110CB40553 140553-102
DB2-B755	ER110CB11463 111463-001	ER110CB11464 111464-001	ER110CB00573 100573-001	ER110CB11462 111462-001	ER110CB45944 145944-001	ER110CB40553 140553-102
DB2-B771				ER110CB16306 S16306-001	ER110CB16313 S16313-001	ER110CB40553 140553-102
DB2-B791				ER110CB00387 S00387-001	ER110CB51594 151594-001	ER110CB40553 140553-102
						
	Barra ago DPx5 (Domestic)	Morsetto ago	Passafilo B/A	Passafilo sx	Passafilo dx	Passafilo ant.
DB2-B735	ER110CB09356 109356-001	ER110CB43931 143931-001 (vite B18521)	ER110CB44577 144577-001 (vite B62630)	ER110CB02617 S02617-001	ER110CB45522 145522-001	ER110CB14931 114931-001
DB2-B737	ER110CB04629 S04629-001			ER110CB02617 S02617-001	ER110CB45522 145522-001	
DB2-B755	ER110CB06408 S06408-001	ER110CB43931 143931-001 (vite B18521)	ER110CB44577 144577-001 (vite B62630)	ER110CB11476 111476-001	ER110CB13316 113316-001	ER110CB14931 114931-001
DB2-B771	ER110CB16310 S16310-001			ER110CB02617 S02617-001	ER110CB45522 145522-001	ER110CB14931 114931-001
DB2-B791	ER110CB07415 107415-022			ER110CB45524 145524-001	ER110CB45526 145526-001	ER110CB14931 114931-001
ALTRE BARRE AGO						
DB2-B735	ER110CB45986 145986-001	DB2-B735-7/ B763	ER110CB17252 117252-001	DB2-B791-5 Standard	ER110CB00399 S00399-001	
DB2-B735-5/ B737-5	ER110CB02811 S02811-001	DB2-B790	ER110CB18685 118685-001	DB2-B791-5	ER110CB59504 159504-001	
						
			Gr. tens. superiore			
DB2-B735	DB2-B737	DB2-B755	DB2-B771	DB2-B791		
ER110CB44502 144502-001	ER110CB47557 147557-001 (Solo perno forato)	ER110CB44502 144502-001	ER110CB47557 147557-001 (Solo perno forato)	ER110CB44502 144502-001		

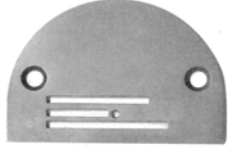
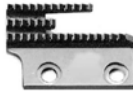
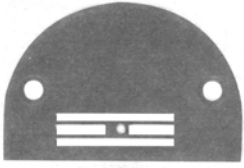
Cl. DB2-B735/B77/B755/B771/B791 segue

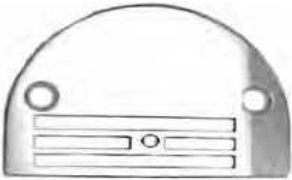
						
	Gr. PRETens. CPL					
DB2-B737	ER110CB83124 183124-001	ER110CB02611 S02611-001	ER110CB02612 S02612-001	ER110CB44504 144504-001	ER110CB54560 154560-001	
DB2-B771	ER110CB83377 183377-001	ER110CB02611 S02611-001	ER110CB02612 S02612-001	ER110CB44504 144504-001	ER110CB54562 154562-001	
DB2-B791	ER110CB83378 183378-001	ER110CB54563 154563-001	ER110CB54559 154559-001	ER110CB44504 144504-001	ER110CB54562 154562-001	ER110CB55510 155510-001
						
	Gr. tensione CPL					
DB2-B735	ER110CB83175 183175-001	ER110CB44741 144741-001	ER110CB14294 114294-001	ER110CB00400 100400-001	ER110CB45519 145519-001	
DB2-B737	ER110CB02618 S02618-001	ER110CB44741 144741-001	ER110CB14294 114294-001	ER110CB03676 S03676-001	ER110CB02620 S02620-000	
DB2-B755	ER110CB81473 181473-001	ER110CB44741 144741-001	ER110CB14294 114294-001	ER110CB00400 100400-001	ER110CB10399 100399-001	
DB2-B771	ER110CB83509 183509-001	ER110CB03254 S03254-001	ER110CB14294 114294-001	ER110CB12699 S12699-001	ER110CB02620 S02620-000	
DB2-B791	ER110CB83513 183513-001	ER110CB03254 S03254-001	ER110CB14294 114294-001	ER110CB12699 S12699-001	ER110CB45519 145519-001	
						
DB2-B735	ER110CB00398 100398-001	ER110CB45446 145446-001	ER110CB59805 159805-001		ER110CB04525 104525-001	
DB2-B737	ER110CB02619 S02619-001	ER110CB45446 145446-001	ER110CB02621 S02621-001	ER110CB02622 S02622-001	ER110CB04525 104525-001	
DB2-B755	ER110CB00398 100398-001	ER110CB45446 145446-001	ER110CB00134 100134-001		ER110CB04525 104525-001	
DB2-B771	ER110CB16922 116922-001	ER110CB45446 145446-001	ER110CB59805 159805-001		ER110CB04525 104525-001	
DB2-B791	ER110CB16922 116922-001	ER110CB45446 145446-001	ER110CB59805 159805-001		ER110CB45520 145520-001	
						
DB2-B735		ER110CB00136 100136-001				
DB2-B737	ER110CB02624 S02624-001		ER110CB02625 S02625-001	ER110CB02627 S02627-001	ER110CB02628 S02628-001	
DB2-B755		ER110CB00136 100136-001				
DB2-B771	ER110CB12441 S12441-001			ER110CB11182 S11182-001		
DB2-B791	ER110CB12441 S12441-001			ER110CB11182 S11182-001		

CI. DB2-B735/B77/B755/B7200 segue (placche e griffe)

					
			FORO	LUNGH. RANGHI POST.	LUNGH. RANGHI ANT.
B12	ER110CB53147 153147-001 (146233-001)	ER110CB00334 100334-001 (146231-001)	1,2	21	15,7
B14	ER110CB46050 S46050-001	ER110CB02742 S02742-001 (S07649-001)	1,4	21	14
B16	ER110CB53190 153190-001	ER110CB02742 S02742-001	1,6	21	14
B18	ER110CB00266 100266-001 (145971-001)	ER110CB02742 S02742-001 (147493-001)	1,8	21	14
B22	ER110CB00267 100267-001	ER110CB02743 S02743-001	2,2	21	14
B26	ER110CB11241 111241-001 (147245-001)	ER110CB02743 S02743-001	2,6	21	14
C26	ER110CB11508 111508-001 (147322-001)	ER110CB02743 S02743-001 (154742-001)	2,6	21	16
H18	ER110CB41096 141096-001	ER110CB17442 117442-001	1,8	21	14
					
			FORO	LUNGH. RANGHI POST.	LUNGH. RANGHI ANT.
A12	ER110CB17216 117216-001	ER110CB11898 111898-001	1,2	14,5	13,3
A14	ER110CB00603 100603-001 (146053-001)	ER110CB11898 111898-001	1,4	14,5	13,3
AB14	ER110CB02999 S02999-001 (S35776-001)	ER110CB02748 S02748-001	1,4	18	14,3
AB16	ER110CB03000 S03000-001	ER110CB02748 S02748-001	1,6	18	14,3
AB18	ER110CB56116 156116-001	ER110CB02748 S02748-001 (S13684-001)	1,8	18	14,3
E12	ER110CB03882 S03882-001	ER110CB03885 S03885-001	1,2	18	13,3
E14	ER110CB03883 S03883-001 (159859-001)	ER110CB03885 S03885-001	1,4	18	13,3
E16	ER110CB11859 111859-001 (S03884-001)	ER110CB11860 111860-001 (SA2345-001)	1,6	18	13,3
					
			FORO	LUNGH. RANGHI POST.	LUNGH. RANGHI ANT.
H18	ER110CB30103 S30103-001	ER110CB25822 S25822-001	1,8	17,2	16,1
H26	ER110CB25821 S25821-001	ER110CB25822 S25822-001	2,6	17,2	16,1
H26	ER110CB50791 150791-001	ER110CB50792 150792-001	2,6	25	19
		ER110CB10032 100032-004 Vite placca		ER110CB00080 100080-003 Vite griffa	

CI. DB2-B791/B7910/B7220A segue (placche e griffe)

			FORO	Distanza denti
Standard	ER110CB43855 143855-001(S11156-001)	ER110CB01158 S01158-001	2,0 slot	1,15
Standard	ER110CB43855 143855-001(S11156-001)	ER110CB03357 S03357-001	1,4	1,15
Standard	ER110CB43855 143855-001(S11156-001)	ER110CB59521 159521-001	2	1,15
Standard	ER110CB43855 143855-001(S11156-001)	ER110CB59522 159522-001	3,6	1,15
Media	ER110CB01988 S01988-001	ER110CB01989 S01989-001	2	1,5
Pesante	ER110CB13101 S13101-001	ER110CB13102 S13102-001	2,4	2
	ER110CB10032 100032-004 Vite placca		ER110CB00080 100080-003 Vite griffa	